

# CRL SLIDING SHOWER DOOR SYSTEMS

**C.R. LAURENCE COMPANY**

WORLDWIDE MANUFACTURER AND SUPPLIER

Glazing, Architectural, Railing, Construction, Industrial, and Automotive Supplies

[crlaurence.com](http://crlaurence.com) | [usalum.com](http://usalum.com) | [crl-arch.com](http://crl-arch.com)

**CRL**<sup>®</sup>  
**US ALUMINUM**  
A CRH COMPANY

# CRL SLIDING SHOWER DOOR SYSTEMS

Frameless shower door systems have evolved over the years in response to changing aesthetic tastes and functional needs. C.R. Laurence has been at the forefront of this evolution, continually designing and engineering frameless shower door systems for today's residential and commercial applications.

Frameless sliding shower doors have risen in popularity and are here to stay. Their appeal lies in their ability to save space and provide contemporary, all-glass aesthetics. C.R. Laurence is proud to offer a complete line of frameless sliding shower door systems in several attractive finishes to complement any decor. You can select from double bypass door configurations such as our new Cambridge Series, or single sliding door systems like our new Crescent Series.

Our goal is to develop products of unsurpassed quality, function, and visual appeal, which is why we stay on top of the latest trends and innovations. C.R. Laurence is the industry standard when it comes to frameless shower door systems. Look through these pages and you'll find out why.

- Diverse Line of Sliding Shower Door Systems for Any Application
- NEW Bypass Sliding Door and Single Sliding Door Models
- Both Top Hung and Bottom Rolling Systems Available
- Optional "Softbrake" on Select Models Prevents Door Collision
- Rigorously Tested to Meet Industry Standards for Performance



Installed by American Frameless





Installed by American Frameless



Installed by Larry Gautreau Co.

TO SEE MORE BEAUTIFUL SHOWERS,  
LOG ON TO [CRLAURENCE.COM/GALLERY](http://CRLAURENCE.COM/GALLERY)  
AND VISIT OUR SHOWER GALLERY.



Installed by Palgrave Glass & Mirror

# CRESCENT SERIES FRAMELESS SLIDING SHOWER DOOR SYSTEM

**NEW**

- System Features One Sliding Door and One Fixed Panel
- Quality Roller Bearings Assure Quiet Door Movement
- Circular Header and Rollers Provide Symmetrical Aesthetics
- Polished Stainless, Brushed Stainless, and Matte Black Finishes
- Handle or Knob for Door Glass Ordered Separately
- Glass Clamps or U-Channel for Fixed Panel Ordered Separately
- Accommodates 1/2" or 3/8" (12 or 10 mm) Thick Tempered Safety Glass (Not Included)

The circular shaped Header and the round Rollers of the Crescent Series Sliding Door System are the perfect complement to each other. They help provide a luxurious sliding shower door system and also a soft décor. The use of minimal hardware lends itself to the popular modern sliding shower door systems by showing more glass, and less hardware. The high quality Rollers assure quiet door travel, and make the door easy to slide. The Crescent Series Sliding System accommodates 1/2" or 3/8" (12 or 10 mm) thick tempered safety glass (not included), and the system allows that the fixed and sliding panels are reversible for installation as desired. The Crescent Series Sliding Door System is available in a choice of polished stainless steel, brushed stainless steel, or the new popular matte black finish.



Installed by Bay Glass Works, Inc.

**SPECIFICATIONS:**

**Material:** Stainless Steel  
**Glass Thickness:** 1/2" or 3/8" (12 or 10 mm) - Not Included  
**Maximum Door Size:** 36" (914 mm) wide or 100 lbs (45 kg) - Do not exceed either width or weight  
**Glass Fabrication Required for Both Door and Fixed Panel**

**FINISHES:**

-  Polished Stainless Steel
-  Brushed Stainless Steel
-  **NEW** Matte Black

**STANDARD 180 DEGREE KIT INCLUDES:**

- One - 78" (1981 mm) Length of Header Bar
- Four - Rollers
- One - Stopper
- Two - Wall Mount Fittings
- Two - Track Holder Fittings for Fixed Panel
- One - Bottom Guide (includes inserts for both 1/2" and 3/8" (12 and 10 mm) Glass)
- Two - 40" (1016 mm) Bottom Sweeps with Drip Rail (one for 3/8" (10 mm) and one for 1/2" (12 mm) Glass)
- One - 80" (2032 mm) Clear L-Jamb

**NOTE:** Customer to supply choice of Handle or Knob for door, and Glass Clamps or U-Channel for fixed panel.

USE MONOLITHIC TEMPERED GLASS FOR GLASS THICKNESSES

1/2" (12 MM)	3/8" (10 MM)	5/16" (8 MM)	1/4" (6 MM)
✓	✓		

**CRESCENT SLIDING SHOWER DOOR SYSTEM**

CAT. NO.	DESCRIPTION	FINISH
CRE78BS	Complete 180° Crescent Series Sliding System	Brushed Stainless
CRE78PS	Complete 180° Crescent Series Sliding System	Polished Stainless
CRE78MBL	Complete 180° Crescent Series Sliding System	Matte Black
CREH1BS	Replacement 78" (1981 mm) Header Bar Only	Brushed Stainless
CREH1PS	Replacement 78" (1981 mm) Header Bar Only	Polished Stainless
CREH1MBL	Replacement 78" (1981 mm) Header Bar Only	Matte Black
CRER2BS	Replacement Rollers (2 per Pack)	Brushed Stainless
CRER2PS	Replacement Rollers (2 per Pack)	Polished Stainless
CRER2MBL	Replacement Rollers (2 per Pack)	Matte Black
CRES1BS	Replacement Stopper	Brushed Stainless
CRES1PS	Replacement Stopper	Polished Stainless
CRES1MBL	Replacement Stopper	Matte Black
CREF1BS	Replacement Fixed Panel Fitting	Brushed Stainless
CREF1PS	Replacement Fixed Panel Fitting	Polished Stainless
CREF1MBL	Replacement Fixed Panel Fitting	Matte Black
CREW1BS	Replacement Wall Mount Fitting	Brushed Stainless
CREW1PS	Replacement Wall Mount Fitting	Polished Stainless
CREW1MBL	Replacement Wall Mount Fitting	Matte Black
CREG1BS	Replacement Bottom Guide	Brushed Stainless
CREG1PS	Replacement Bottom Guide	Polished Stainless
CREG1MBL	Replacement Bottom Guide	Matte Black
DK80L	Replacement 80" (2032 mm) L-Jamb (2 each)	Clear
P995WS	Replacement 40" (1016 mm) Bottom Sweep for 3/8" (10 mm)	Clear
P997WS	Replacement 40" (1016 mm) Bottom Sweep for 1/2" (12 mm)	Clear

Customer to supply choice of Handle or Knob for door, and Glass Clamps or U-Channel for fixed panel.



# SENIOR DELUXE SERENITY SERIES FRAMELESS SLIDING SHOWER DOOR SYSTEM

- **Exclusively for 1/2" (12 mm) Thick Tempered Glass (Not Included)**
- Similar to Popular Deluxe Serenity Series Sliding Shower Door System
- System Features the Use of Minimal Hardware to Give Enclosure An Almost Floating Appearance
- Basic 180 Degree System Features Hardware for One Sliding Door and One Fixed Panel
- Accessory Kit Purchased Separately for 90 Degree Return Panels

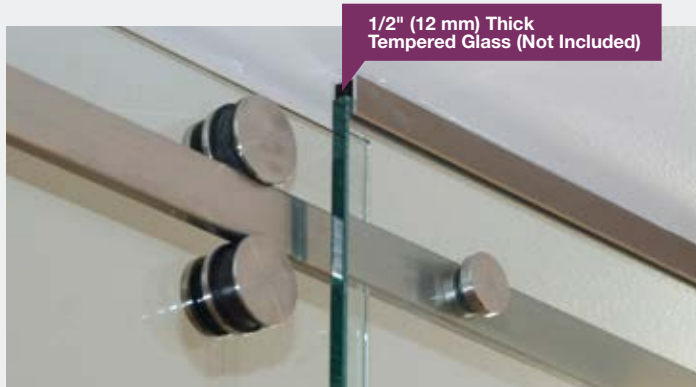

The popularity of our Deluxe Serenity Sliding Shower Door System led to the next logical step, which is the introduction of our Senior Deluxe Serenity Sliding Shower Door System for use only with 1/2" (12 mm) thick tempered safety glass (not included). Utilizing many of the attractive and practical features of the Deluxe Serenity, Senior Deluxe Serenity is sure to grab attention with its majestic appearance in an elegant bathroom. The Senior Deluxe

Serenity Kit comes with the hardware for installation of a 180 degree door and fixed panel, except U-channel or glass clamps, which are ordered separately. Also purchased separately, our Senior 90 Degree Accessory Kit (Cat. No. SRSER90) can be used to construct enclosures having a 90 degree return panel. The Senior Deluxe Serenity Sliding Kit is available in a choice of polished or brushed stainless steel.

**SPECIFICATIONS:**

**Glass Thickness:**  
1/2" (12 mm) Tempered Safety Glass (Not Included)  
**Material:** Stainless Steel  
**Maximum Door Size:** Do Not Exceed Either 30" (762 mm) Wide or 110 Pounds (50 kg)  
**Glass Fabrication:** Holes Required in Both Door and Fixed Panel  
(see [crlaurence.com/shower-sliders](http://crlaurence.com/shower-sliders) for details)

**FINISHES:**



USE MONOLITHIC TEMPERED GLASS FOR GLASS THICKNESSES			
1/2" (12 MM)	3/8" (10 MM)	5/16" (8 MM)	1/4" (6 MM)
✓			

POLISHED STAINLESS CAT. NO.	BRUSHED STAINLESS CAT. NO.	DESCRIPTION
SRSER78PS	SRSER78BS	Standard 180 Degree Kit
SRSERH2PS	SRSERH2BS	78-3/4" (2 m) Replacement Header Bar Only
SRSERR4PS	SRSERR4BS	Replacement Roller (1 each)
SRSESR4PS	SRSESR4BS	Replacement Stopper (1 each)
SRSERF4WPS	SRSERF4WBS	Replacement Track Holder Fittings For Wall (1 pair)
SRSERF4PPS	SRSERF4FPBS	Replacement Track Holder Fittings For Fixed Panel (1 pair)
SERDG2PS	SERDG2BS	Replacement Door Guide
SERNHP2PS	SERNHP2BS	Replacement Thru-Glass Pull
DK98L	DK98L	95" (2.41 m) Replacement Clear Plastic L-Seal
SRSER90PS	SRSER90BS	Accessory Kit for 90 Degree Return

*U-Channel or Glass Clamps for fixed panels must be ordered separately.*

**STANDARD 180 DEGREE KIT INCLUDES:**

- One - 78-3/4" (2 m) Length Header Bar
- Four - Rollers
- One - Stopper
- Two - Track Holder Fittings for Wall
- Two - Track Holder Fittings for Fixed Panel
- One - Thru-Glass Pull
- One - Door Guide
- One - 85" (2.16 m) Clear L-Jamb

# DELUXE SERENITY SERIES FRAMELESS SLIDING SHOWER DOOR SYSTEM

- Unique 180 Degree System With Rollers Above and Below the Header Bar
- System Features One Sliding Door and One Fixed Panel
- Fixed and Sliding Glass Panels are Reversible for Installation
- Use of Minimal Hardware Gives Door an Almost Floating Appearance
- Accessory Kit Available for 90 Degree Return Panels (Cat. No. SER90)



Installed by American Frameless

Our Deluxe Serenity Series Frameless Sliding Shower Door System has an entirely different look from traditional sliding shower doors. The unique roller system operates above and below the header bar spanning the top of the enclosure. Specially designed roller bearings allow for quiet and easy opening and closing of the

door. The use of minimal hardware provides a frameless look that gives the enclosure an almost floating appearance. One sliding and one fixed panel make the 180 Degree Standard Kit beautiful and practical. Units will work with 3/8" or 5/16" (10 or 8 mm) thick tempered glass (not included).

**SPECIFICATIONS:**

**Glass Thickness:**  
3/8" or 5/16" (10 or 8 mm) - Not Included  
**Material:** Stainless Steel  
**Maximum Door Size:** Do Not Exceed  
Either 30" (762 mm) Wide or 88 Pounds (40 kg)  
**Glass Fabrication:** Holes Required in Both Door and Fixed Panel (see [crlaurence.com/shower-sliders](http://crlaurence.com/shower-sliders) for details)

**STANDARD 180 DEGREE KIT INCLUDES:**

- One - 78-3/4" (2 m) Length Header Bar
- Four - Rollers
- One - Stopper
- Two - Track Holder Fittings for Wall
- Two - Track Holder Fittings for Fixed Panel
- One - Thru-Glass Pull
- One - Door Guide
- One - 85" (2.16 m) Clear L-Jamb

**FINISHES:**



**CAT. NO. SERCAP**  
Optional Screw Caps  
6/Pack (Install with a dab of 33SMRC Silicone)

USE MONOLITHIC TEMPERED GLASS FOR GLASS THICKNESSES

1/2" (12 MM)	3/8" (10 MM)	5/16" (8 MM)	1/4" (6 MM)
	✓	✓	

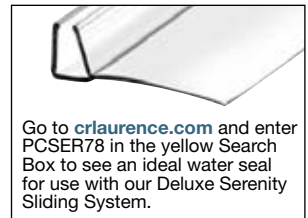

POLISHED STAINLESS CAT. NO.	BRUSHED STAINLESS CAT. NO.	MATTE BLACK CAT. NO.	DESCRIPTION
SER78PS	SER78BS	SER78MBL	Standard 180 Degree Kit
SER90PS	SER90BS	SER90MBL	90 Degree Accessory Kit
SERH2PS	SERH2BS	SERH2MBL	78-3/4" (2 m) Replacement Header Bar Only
SERNR1PS	SERNR1BS	SERNR1MBL	Replacement Roller (1/Pack)
SERNS1PS	SERNS1BS	SERNS1MBL	Replacement Stopper (1/Pack)
SERAHW2PS	SERAHW2BS	SERAHW2MBL	Track Holder Fittings For Wall (2/Pack)
SERFP2PS	SERFP2BS	SERFP2MBL	Track Holder Fittings For Fixed Panel (2/Pack)
SERUG2PS	SERUG2BS	SERUG2MBL	Replacement Door Guide (1/Pack)
SERNHP2PS	SERNHP2BS	SERNHP2MBL	Replacement Thru-Glass Pull
DK98L	DK98L	DK98L	95" (2.41 m) Replacement Clear Plastic L-Seal
SERCAPPS	SERCAPBS	SERCAPMBL	Optional Screw Caps (6/Pack)

U-Channel or Glass Clamps for fixed panels must be ordered separately.

# DELUXE SERENITY SERIES V-CORNER SYSTEM

- Create an Attractive 90 Degree Double Door Corner System More Easily Than Ever Before
- Simply Purchase Two Deluxe Serenity 180 Degree Kits and One 90 Degree Double Door Connector Bracket
- V-Corner Design Ideal for Smaller Bathrooms
- Choice of Polished or Brushed Stainless Finishes
- Matte Black is Available on Special Order

Creating a unique and attractive V-Corner shower enclosure is now easier than ever. Simply purchase two 180 Degree Serenity Series Sliding Systems (see previous page), along with one 90 Degree Double Door Connector Bracket (see below). Combining the two sliding doors in a V-corner allows you to build a beautiful double door sliding enclosure ideal for smaller bathroom areas. A choice of beautiful and durable polished or brushed stainless steel finishes help to match most any modern bathroom décor. Matte Black is available on special order.

No glass fabrication is required for the Connector Bracket itself. Minimum order is one each. **NOTE:** Each Sliding Door Cannot Exceed 17" (432 mm) in width or 51 Pounds (23 kg).

Front View

Rear View

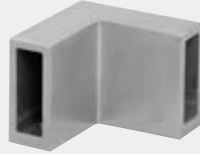
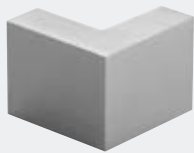

90 Degree Door Connector Bracket

**CAT. NO. SERC2BS**  
Brushed Stainless

**CAT. NO. SERC2PS**  
Polished Stainless

Matte Black is available  
on special order

**FINISHES:**

-  Polished Stainless Steel
-  Brushed Stainless Steel

USE MONOLITHIC TEMPERED GLASS FOR GLASS THICKNESSES			
1/2" (12 MM)	3/8" (10 MM)	5/16" (8 MM)	1/4" (6 MM)
	✓	✓	



TO SEE MORE BEAUTIFUL SHOWERS,  
LOG ON TO [CRLAURENCE.COM/GALLERY](http://CRLAURENCE.COM/GALLERY)  
AND VISIT OUR SHOWER GALLERY.

Installed by  
**Americian**  
Frameless

# CAMBRIDGE SERIES TWO DOOR BYPASS FRAMELESS SLIDING SHOWER DOOR SYSTEM

**NEW**

- Modern Two Door Bypass System
- Top Rollers Assure Easy Sliding Action
- Minimal Use of Hardware Adds to Visual Appeal
- Attractive Polished and Brushed Stainless, and Matte Black Finishes
- For Use With 3/8" or 5/16" (10 or 8 mm) Thick Monolithic Tempered Safety Glass (Not Included)



Installed by Custom Closet & Glass

The **NEW** Cambridge Series Two Door Bypass Sliding Shower Door System utilizes a modern top roller system that features four rollers on each door for ease of sliding. This quiet, smooth sliding system is made of high quality stainless steel, thus ensuring easy opening and closing of the doors. The Cambridge Series is versatile in design, able to adapt to full standing showers or above bathtubs. Each kit includes the following: 73" (1854 mm) length stainless steel Header; 8 stainless steel Rollers; 2 Stoppers; 2 Track Holder

Fittings for the wall; 1 stainless steel Bottom Guide; 2 each 24" (610 mm) Single-Sided Towel Bars; 2 each 40" (1016 mm) Bottom Door Sweeps; 2 each 80" (2032 mm) length Clear L-Jamb; 1 Tool Kit. The Cambridge Series Bypass Sliding Shower Door System accommodates 3/8" or 5/16" (10 or 8 mm) thick tempered safety glass (not included). Your choice of beautiful polished or brushed stainless steel finish, or matte black allows design options. A 90 Degree Accessory Kit is available for enclosures with a return panel.

**SPECIFICATIONS:**

**Glass Thickness:** 3/8" or 5/16" (10 or 8 mm) - (Glass Not Included)  
**Material:** Stainless Steel  
**Maximum Door Size:** 37" (940 mm) Wide or 84 Pounds (38 kg) for Each Door – Do Not Exceed Either Width or Weight  
**Glass Fabrication Required:**  
 One 3/4" (19 mm) Diameter Hole Per Roller;  
 Two 1/2" (12 mm) Diameter Holes Per Towel Bar

**FINISHES:**

-  Polished Stainless Steel
-  Brushed Stainless Steel
-  **NEW** Matte Black

USE MONOLITHIC TEMPERED GLASS FOR GLASS THICKNESSES			
1/2" (12 MM)	3/8" (10 MM)	5/16" (8 MM)	1/4" (6 MM)
	✓	✓	

POLISHED STAINLESS CAT. NO.	BRUSHED STAINLESS CAT. NO.	MATTE BLACK CAT. NO.	DESCRIPTION
CAM73PS	CAM73BS	CAM73MBL	Standard 180 Degree Cambridge Kit Replacement 73" (1854 mm) Header Bar
CAMH1PS	CAMH1BS	CAMH1MBL	
CAMR4PS	CAMR4BS	CAMR4MBL	Replacement Rollers (1 Pack of 8)
CAMS1PS	CAMS1BS	CAMS1MBL	Replacement Stoppers (1 Pack of 2)
CAMW2PS	CAMW2BS	CAMW2MBL	Replacement Track Holder Fittings for the Wall (1 Pack of 2)
CAMG1PS	CAMG1BS	CAMG1MBL	Replacement Bottom Guide
BMNW24PS	BMNW24BS	BMNW24MBL	Replacement 24" (610 mm) Single-Sided Towel Bar
P995WS	P995WS	P995WS	Replacement 40" (1016 mm) Bottom Sweep With Drip Rail for 3/8" (10 mm)*
DK80L	DK80L	DK80L	Replacement 80" (2032 mm) Clear L-Jamb (2 each)
CAM90PS	CAM90BS	CAM90MBL	Optional 90 Degree Cambridge Accessory Kit

\*Call for Replacement 5/16" (8 mm) Bottom Sweep





# CONTEMPO SERIES TWO DOOR BYPASS FRAMELESS SLIDING SHOWER DOOR SYSTEM

**NEW**

- Unique “I Beam” Header Style Adds Rigidity to Enclosure
- Designed for Full Standing Showers or Above Bathtubs
- Adjustable Height Header is Clad in Attractive Polished or Brushed Stainless Steel, or Matte Black Finishes
- Accommodates 3/8" or 5/16" (10 or 8 mm) Thick Tempered Safety Glass (Not Included)



Towel Bar and Finger Pull Not Included

The **NEW** Contempo Series “I Beam” Bypass Sliding Shower Door System will be the focus of any bathroom in which it appears. Contempo has the flexibility to be installed either in a full standing shower, or above a bathtub. The Header is clad in polished or brushed stainless steel, or matte black to present an elegant appearance. The Contempo Series has two hangers (four rollers) per door to assure a smooth, gliding opening and closing of the bypassing doors using only fingertip control. The “adjustable height”

header is the installer’s friend, allowing wiggle room for installation. Complete Kits include: 73-13/16" (1875 mm) length Header; 4 each Hangers (8 rollers); 2 each Stoppers; 2 Track Holder Fittings for the wall; 1 each Bottom Guide; 2 each 85" (2159 mm) Clear L-Jamb; 1 each 73-13/16" (1875 mm) Threshold. The customer supplies their own choice of towel bars or knobs. The Contempo Series Sliding System accommodates 3/8" or 5/16" (10 or 8 mm) thick tempered safety glass (not included). A 90 Degree Accessory Kit is available for enclosures with a return panel.

**SPECIFICATIONS:**

**Glass Thickness:** 3/8" or 5/16" (10 or 8 mm) - (Glass Not Included)  
**Material:** Stainless Steel "Cladded" Header  
**Maximum Door Size:** 37" (940 mm) Wide or 84 Pounds (38 kg) for Each Door - Do Not Exceed Either Width or Weight  
**Glass Fabrication Required:**  
 One 5/8" (16 mm) Diameter Hole Per Hanger

**FINISHES:**

-  Polished Stainless Steel
-  Brushed Stainless Steel
-  **NEW** Matte Black

USE MONOLITHIC TEMPERED GLASS FOR GLASS THICKNESSES			
1/2" (12 MM)	3/8" (10 MM)	5/16" (8 MM)	1/4" (6 MM)
	✓	✓	

POLISHED STAINLESS CAT. NO.	BRUSHED STAINLESS CAT. NO.	MATTE BLACK CAT. NO.	DESCRIPTION
CON73PS	CON73BS	CON73MBL	Standard 180 Degree Contempo Kit
CONH1PS	CONH1BS	CONH1MBL	Replacement 73-13/16" (1875 mm) Header Bar
CONR4PS	CONR4BS	CONR4MBL	Replacement Hangers (1 Pack of 4)
CONS2PS	CONS2BS	CONS2MBL	Replacement Stoppers (1 Pack of 2)
CONW2PS	CONW2BS	CONW2MBL	Replacement Track Holder Fittings (1 Pack of 2)
CONG1PS	CONG1BS	CONG1MBL	Replacement Bottom Guide
SDT440PS	SDT440BS	SDT440MBL	Replacement 73-13/16" (1875 mm) Threshold
DK98L	DK98L	DK98L	Replacement 95" (2.41 m) Clear L-Jamb
CON90PS	CON90BS	CON90MBL	Optional 90 Degree Contempo Accessory Kit

# HYDROSLIDE FRAMELESS SLIDING SHOWER DOOR KITS

- Excellent Design for Compact Areas
- Clean, Sleek Lines
- Available in Four Stock Finishes, Custom Finishes Available
- Standard 180 Degree Installation is One Fixed Panel and One Door
- Custom Units Available

USE MONOLITHIC TEMPERED GLASS FOR GLASS THICKNESSES

1/2" (12 MM)	3/8" (10 MM)	5/16" (8 MM)	1/4" (6 MM)
	✓	✓	



**90 DEGREE WALL-TO-WALL INSTALLATION**  
Uses our 180 Degree Standard Kit plus a 90 Degree Wall-to-Glass Accessory Kit



Installed by Palgrave Glass & Mirror

Hydroslide Sliding Shower Door Kits were designed for full standing showers or above bathtubs. The Hydroslide System can accommodate a wide range of shower designs with fixed glass panels on either end, or both sides at 90 or 180 degrees. The Hydroslide System also accommodates the option of floor-to-near-ceiling glass panels with a sliding door.

180 Degree Hydroslide Sliding Shower Door Kits feature the latest European 'all-glass' look. Kits are available in either 60" or 84" (1524 or 2134 mm) widths. Installers can cut the width to size, and height is optional as long as the sliding door glass weighs less than 88 pounds (40 kg). The 180 Degree Wall-to-Wall Installation only requires the 180 Degree Standard Kit for the installation.

## SLIDING DOOR FLOOR GUIDE KIT



This Guide is the standard one supplied with Hydroslide Kits. Consists of one Floor Guide and two Screws.

CAT. NO.	FINISH
HYD03CH	Polished Chrome
HYD03BR	Polished Brass
HYD03BN	Brushed Nickel
HYD03ORB	Oil Rubbed Bronze

## GUIDE FOR USE WITH HYD98 BOTTOM SWEEP

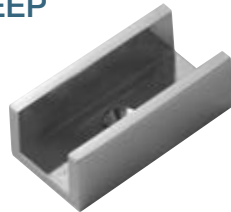

This metal guide allows the use of our HYD98 Bottom Sweep (purchased separately) by having it fit inside the Guide itself, thus minimizing water leakage for Hydroslide Sliding Door Systems.

CAT. NO.	FINISH
HYD08CH	Polished Chrome
HYD08BR	Polished Brass
HYD08BN	Brushed Nickel
HYD08ORB	Oil Rubbed Bronze

## OFFSET GUIDE FOR USE WITH HYD98 BOTTOM SWEEP

This metal Offset guide allows the use of our HYD98 Water Management Sweep (purchased separately) by having it fit inside the Guide itself, thus minimizing water leakage for Hydroslide Sliding Door Systems. The extended metal plate on the Guide is offset to assist with uneven curb conditions.

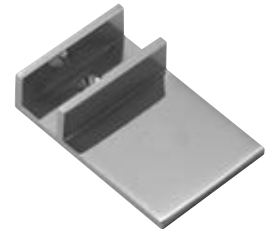

CAT. NO.	FINISH
HYD09CH	Polished Chrome
HYD09BR	Polished Brass
HYD09BN	Brushed Nickel
HYD09ORB	Oil Rubbed Bronze

## HYDROSLIDE BOTTOM SWEEP

Fits in both our HYD08 and HYD09 Sliding Door Guides, minimizing water leakage. 98" (2.49 m) length.

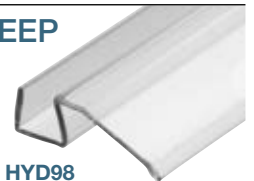

CAT. NO. HYD98

## HYDROSLIDE "U" SEAL WITH 90 DEGREE FIN

Go to [crlaurence.com](http://crlaurence.com) and enter PC0890 (for 5/16" or 8 mm glass) or PC1090 (for 3/8" or 10 mm glass) in the yellow Search Box to see an ideal water seal for use with our Hydroslide Sliding System.

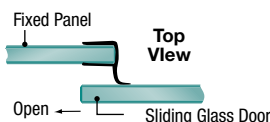

CAT. NO. PC1090 - for 3/8" (10 mm) glass  
CAT. NO. PC0890 - for 5/16" (8 mm) glass



90 Degree wall-to-glass installations require the 180 Degree Standard Kit, plus the 90 Degree Wall-to-Glass Accessory Kit. Individual or replacement parts can be seen on page 8. Bottom Fixed Glass Attachments and Handles or Knobs must be ordered separately.

Hydroslide Kits come in four finishes: Chrome Fittings with a Brite Anodized Sliding Track, Polished Brass with a Brite Gold Anodized Sliding Track, Brushed Nickel with Brushed Nickel Anodized Sliding Track, and Oil Rubbed Bronze with Oil Rubbed Bronze Anodized Sliding Track.

**180 DEGREE WALL-TO-WALL INSTALLATION**  
Uses our 180 Degree Standard Kit

**SPECIFICATIONS:**

**Materials:** Plated or Lacquered Solid Brass Fittings; Anodized Aluminum Sliding Door Track  
**Glass Thickness Range:** 3/8" or 5/16" (10 or 8 mm) Tempered Safety Glass (Not Included)  
**Maximum Door Weight:** 88 lbs. (40 kg)  
**Glass Fabrication:** Holes Required in Fixed Panel and Door  
**Include:** Gaskets, Screws, and Glass Fabrication Information. Complete installation instructions, along with glass and metal cutting formula, available at [crlaurence.com/shower-sliders](http://crlaurence.com/shower-sliders)

**FINISHES:**

-  Polished Chrome
-  Polished Brass
-  Brushed Nickel
-  Oil Rubbed Bronze

180 DEGREE STANDARD KIT 60" (1524 MM) CAT. NO.	180 DEGREE STANDARD KIT 84" (2134 MM) CAT. NO.	90 DEGREE WALL-TO-GLASS ACCESSORY KIT CAT. NO.	FINISH
HYDK60CH	HYDK84CH	HYDA9CH	Brite Anodized/Chrome
HYDK60BR	HYDK84BR	HYDA9BR	Brite Gold Anodized/Brass
HYDK60BN	HYDK84BN	HYDA9BN	Brushed Nickel
HYDK60RB	HYDK84ORB	HYDA9ORB	Oil Rubbed Bronze



Installed by AI's Quality Shower Door

## HYDROSLIDE BI-FOLD HINGES

- Glass-to-Wall Mount and Glass-to-Glass Models  
Allow Door to Bi-Fold Into Enclosure

These Hydroslide Bi-Fold Hinges add a different element to the already popular Hydroslide System. Instead of a standard sliding door, you can now "Bi-Fold" two folding panels of glass into the shower enclosure, creating a larger opening than the single sliding door will allow. Made of solid brass, they are available in four popular finishes. DSBF1 Door Stop (shown below) is available for use with this system. Upper Track, Hanger, and accessories are sold separately.

**PANELS "FOLD" INTO THE SHOWER**



**SPECIFICATIONS:**

**Glass Thickness:** 3/8" or 5/16" (10 or 8 mm) Tempered Safety Glass  
**Construction:** Solid Brass  
**Hinge Swings:** Bi-Fold into Shower Enclosure  
**Closing Type:** Free Swinging  
**Holes Required in Glass for Hinges**  
**Includes:** Gaskets, Screws, and Glass Fabrication Dimensions  
**Maximum Capacities:** Do Not Exceed Either 48" (1219 mm) or 100 lbs. (45 kg) for Both Folding Doors Combined. Use Two Hinges Only on Each Folding Panel.

**CAT. NO. HYDH180**  
180° Glass-to-Glass



**CAT. NO. HYDH037**  
Glass-to-Wall Mount



**MODEL DSBF1**  
Door Stop

The Door Stop for CRL's Hydroslide Bi-Fold Hinge System will protect the shower door from closing too far and damaging the door. No glass fabrication is required.

Hydroslide Bi-Fold Hinges require holes in the glass



# ESSENCE SERIES BOTTOM ROLLING FRAMELESS SHOWER DOOR SYSTEM

- Headerless System Offers Popular Frameless Look
- Bottom Rolling System has Integrated Height Adjustment
- Rollers Include Anti-Derail/Anti-Pinch Guard
- Choice of Rounded or Square Style Roller System
- For Use Only With 1/2" (12 mm) Thick Tempered Glass (Not Included)



US Patent No. 9364121  
 Australian Patent No. 2012328876  
 Canadian Patent No. 2853462  
 Deutsches Patent No. 2770890

USE MONOLITHIC TEMPERED GLASS FOR GLASS THICKNESSES			
1/2" (12 MM)	3/8" (10 MM)	5/16" (8 MM)	1/4" (6 MM)
✓			



ESS1  
Rounded  
Roller Style



ESS3  
Square Corner  
Roller Style

POLISHED CHROME CAT. NO.	BRUSHED NICKEL CAT. NO.	POLISHED BRASS CAT. NO.	OIL RUBBED BRONZE CAT. NO.	DESCRIPTION
ESS1CH	ESS1BN	ESS1BR	ESS1ORB	Basic Rounded Roller Style Essence Kit
ESS3CH	ESS3BN	ESS3BR	ESS3ORB	Basic Square Cornered Roller Style Essence Kit
BR4CH	BR4BN	BR4BR	BR4ORB	Replacement Rounded Style Bottom Roller
SR4CH	SR4BN	SR4BR	SR4ORB	Replacement Square Cornered Bottom Roller
TG4CH	TG4BN	TG4BR	TG4ORB	Replacement Top Guide
BT4CH	BT4BN	BT4BR	BT4ORB	64" (1.63 m) Replacement Bottom Track
SDCD12BA	SDCD12BN	SDCD12BGA	SDCD12ORB	95" (2.41 m) Replacement U-Channel
DK98L	DK98L	DK98L	DK98L	95" (2.41 m) Replacement Clear Plastic L-Seal

NOTE: Glass Brackets, Door Handle or Knob, and Other Items Sold Separately.



Installed by Crystal Glass & Mirror Corp.

Our Essence Series allows a headerless appearance by utilizing a bottom rolling system that includes an anti-derail/anti-pinch guard feature. The bottom rollers also have an integrated height adjustment for door to vertical jamb alignment. By being completely header-free, a frameless vertical and horizontal appearance is achieved. Smooth and quiet operation of the door is the cornerstone of this bottom rolling unit. At the same time, excellent water management is accomplished at the sill via the bottom track, and vertically with the use of a clear L-shape jamb.

Sold in a Basic Kit that allows both 180 degree and 90 degree installations, the user simply orders the necessary Brackets, plus the Handle or Knob separately, to complete the installation.

See the important How to Order Section below.

Go to [crlaurence.com/shower-sliders](http://crlaurence.com/shower-sliders) to see the Essence Sliding Shower Door System With Header as an alternate sliding system.

**SPECIFICATIONS:**

**Glass Thickness:** 1/2" (12 mm) Tempered Safety Glass (Not Included)

**Materials:** Rollers and Top Guide (Solid Brass); Bottom Sliding Track and U-Channel (Aluminum); L-Jamb (Polycarbonate)

**Maximum Door Size:** Do Not Exceed Either 34" (864 mm) Wide or 127 Pounds (57.6 kg)

**Basic Kit Glass Fabrication:** Notch Required for Bottom Rollers, Holes Required for Top Guide

**Note:** Wall Mount and Glass-to-Glass Brackets also Require Glass Fabrication (see [crlaurence.com/shower-sliders](http://crlaurence.com/shower-sliders) for details)

**HOW TO ORDER FOR 180 DEGREE WALL-TO-WALL INSTALLATION:**

1. Order Basic ESS1 (Rounded) or ESS3 (Square Cornered) Kit in Your Choice of Finish
2. Order Two Each CL90S (Rounded) or GE90S (Square Cornered) Wall Mount Brackets
3. Order Your Choice of Handle or Knob for Door
4. Order Any Other Accessories You May Want for the Enclosure

**HOW TO ORDER FOR 90 DEGREE RETURN PANEL INSTALLATION:**

1. Order Basic ESS1 (Rounded) or ESS3 (Square Cornered) Kit in Your Choice of Finish
2. Order Two Each CL90S (Rounded) or GE90S (Square Cornered) Wall Mount Brackets plus Two Each CL090 (Rounded) or GE090 (Square Cornered) Glass-to-Glass Brackets
3. Order Your Choice of Handle or Knob for Door
4. Order Any Other Accessories You May Want for the Enclosure

**BASIC ESS1 OR ESS3 KITS INCLUDE THE FOLLOWING:**

- Two - Bottom Rollers
  - One - Spanner Wrench for Roller Adjustment
  - One - Top Door Guide
  - One - 64" (1.63 m) Bottom Track
  - One - 95" (2.41 m) U-Channel
  - One - 95" (2.41 m) Plastic L-Seal
  - One - SDCEC12 End Cap for Channel
  - Two - Shower Door Bumpers
  - One - 1/16" (1.6 mm) Neoprene Setting Block
- NOTE:** Glass Brackets, Handle or Knob, and Other Accessories Sold Separately

**FINISHES:**



Go to [crlaurence.com](http://crlaurence.com) and enter PC1200 in the yellow Search Box to see an ideal water seal for use with our Essence Sliding System.



# CABO SOFT SLIDE FRAMELESS SLIDING SHOWER DOOR SYSTEM

- Featuring the **'Softbrake'** Braking System Controlling the Last 4" (102 mm) of Door Travel
- Two Widths Available 65" and 84" (1.65 and 2.13 m)
- Hardware for One Sliding Door and One Fixed Panel
- Concealed Overhead Roller Design
- Available in Five Finishes, With Custom Finishes Available

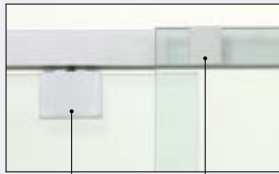

Shown With Square Clamp  
Fixed Glass Connection to Header



Rounded Clamp Style



Square Cornered Clamp Style



Wall Mount Bracket  
(Two included with 180 Degree Kits)



Optional 90 Degree Return Bracket and Wall Clamp  
(Sold Separately, See Below)



The Cabo Soft Slide Sliding Door System offers the 'Softbrake' Braking System on the door, ensuring that you do not have to worry about the door "slamming" open or closed. 'Softbrake' cushions the opening and closing of the door gently, quietly, and is completely concealed inside the header. 'Softbrake' controls the last 4" (102 mm) of door travel, preventing the glass from impacting the frame or adjacent glass panel.

The Cabo Soft Slide Series offers a choice of two clamp cover designs (rounded or square), and is available in five architectural finishes. Each Kit comes complete with a Header, two Top Clamps with Covers, two Wall Mount Brackets, two Top Fixed Glass Fasteners with Covers, and a Bottom Guide. Bottom Fixed Glass Attachments (Channels or Clamps), and Handles must be ordered separately. **NOTE:** Tempered glass is not included.

**SPECIFICATIONS:**

**Glass Thicknesses:** 1/2", 3/8", or 5/16" (12, 10, or 8 mm) Monolithic Tempered Safety Glass (Not Included)

**Material:** Aluminum

**Maximum Door Weight:** 176 lbs (80 kg)

**Finished Opening Size:**

Minimum 60" (1.52 m) Wide for 65" (1.65 m) Kit;  
Minimum 65" (1.65 m) Wide for 84" (2.13 m) Kit

**Glass Fabrication:** Holes and Notches Required

**Includes:** Gaskets, Screws, and Glass Fabrication Information

**FINISHES:**



USE MONOLITHIC TEMPERED GLASS FOR GLASS THICKNESSES			
1/2" (12 MM)	3/8" (10 MM)	5/16" (8 MM)	1/4" (6 MM)
✓	✓	✓	

Go to [crlaurence.com/showers-sliders](http://crlaurence.com/showers-sliders) for additional information and a selection of replacement parts.

**180 DEGREE KITS WITH HEADERS**

OPTIONAL 90 DEGREE RETURN KIT		180 DEGREE KITS WITH HEADERS				FINISH
CAT. NO.	FINISH	65" (1.65 M) ROUNDED STYLE CAT. NO.	84" (2.13 M) ROUNDED STYLE CAT. NO.	65" (1.65 M) SQUARE STYLE CAT. NO.	84" (2.13 M) SQUARE STYLE CAT. NO.	
CAB90CH	Polished Chrome	CABR65CH	CABR84CH	CABS65CH	CABS84CH	Polished Chrome
CAB90SA	Satin Anodized	CABR65SA	CABR84SA	CABS65SA	CABS84SA	Satin Anodized
CAB90BN	Brushed Nickel	CABR65BN	CABR84BN	CABS65BN	CABS84BN	Brushed Nickel
CAB90BR	Polished Brass	CABR65BR	CABR84BR	CABS65BR	CABS84BR	Polished Brass
CAB90DU	Duranodic Bronze	CABR65DU	CABR84DU	CABS65DU	CABS84DU	Duranodic Bronze

**NOTE:** Bottom Fixed Glass Attachments (channels or clamps), and handles must be ordered separately.

# COTTAGE CK SERIES TWO DOOR BYPASS FRAMELESS SLIDING SHOWER DOOR KITS

## CK SERIES WITH CLEAR SIDE JAMBS

- Utilizes Clear Polycarbonate Side Jambs Instead of Traditional Metal Jambs
- Bolt-Through Top Hangers Provided for Immediate Fabrication and Installation
- Designed for Use With 3/8" or 1/4" (10 or 6 mm) Tempered Glass
- Custom Units Available

The Clear Jamb System Changes How You View Frameless Sliding Shower Door Kits Because the Vertical Metal is eliminated



Installed by Al's Quality Shower Door

Cottage CK Series Sliders are unique in that they utilize clear polycarbonate side jambs instead of traditional metal side jambs, thus providing more of the popular 'all-glass' look. Bolt-Through Top Hangers allow immediate fabrication and installation, with no waiting for messy adhesive to dry. Cottage Series Kits come in Brite Anodized, Brite Gold Anodized, Brushed Nickel, and Oil Rubbed Bronze finishes, with other finishes available on special order.

**FINISHES:**

-  Brite Anodized
-  Brushed Nickel
-  Brite Gold
-  Oil Rubbed Bronze

**SPECIFICATIONS:**

**Materials:** Extrusions (Aluminum); Side Jambs (Polycarbonate); Towel Bar (Brass Tubing); Knob (Solid Brass)

**For Glass Thickness:** 3/8" or 1/4" (10 or 6 mm) – (Glass not included in Kit)

**Glass Fabrication:** Towel Bar – Two 1/2" (12 mm) Diameter Holes, 24" (610 mm) Center-to-Center; Knob – One 1/2" (12 mm) Diameter Hole; Top Hangers – Four 1/2" (12 mm) Diameter Holes (two per glass panel)

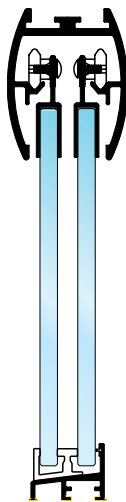

End View of Sliding Panels

The top hung stock units include: Header, Top Hangers for 3/8" or 1/4" (10 or 6 mm) glass, Clear Polycarbonate Side Jambs, Bottom Sill, Back-to-Back Knob, 24" (610 mm) Towel Bar, Nylon Rollers, and Bottom Guide. Tempered glass and silicone sealant are supplied by the installer to complete the installation. Since all rollers are overhead, the Bottom Sill and Clear Side Jambs are uncluttered, making cleaning easy. Available in up to six stock sizes. Extrusions, Bottom Guides, Hardware Packages, and other accessories may be ordered separately as well (see next page).

USE MONOLITHIC TEMPERED GLASS FOR GLASS THICKNESSES			
1/2" (12 MM)	3/8" (10 MM)	5/16" (8 MM)	1/4" (6 MM)
	✓		✓



**COTTAGE CK SERIES SLIDING SHOWER DOOR KITS**

FOR 3/8" (10 MM) GLASS CAT. NO.*	FOR 1/4" (6 MM) GLASS CAT. NO.*	SIZE (WIDTH X HEIGHT)
CK386060	CK146060	60" x 60" (1.52 m x 1.52 m)
CK386072	CK146072	60" x 72" (1.52 m x 1.83 m)
CK386080	---	60" x 80" (1.52 m x 2.03 m)
CK387260	CK147260	72" x 60" (1.83 m x 1.52 m)
CK387272	---	72" x 72" (1.83 m x 1.83 m)
CK387280	---	72" x 80" (1.83 m x 2.03 m)

\* Specify Finish When Ordering



# A COMPARISON OF COTTAGE SERIES FRAMELESS SLIDING SHOWER DOOR KITS

- Clear Side Jambs Make the CK Series Your Choice for the 'All-Glass' Look

## CK SERIES WITH CLEAR SIDE JAMBS

- Typical View of a Custom Inline CK Series Shower Door Unit With Clear Side Jambs and an Adjacent Full Length Fixed Glass Panel
- Example Shown is for Use With 3/8" (10 mm) Tempered Glass

USE MONOLITHIC TEMPERED GLASS FOR GLASS THICKNESSES			
1/2" (12 MM)	3/8" (10 MM)	5/16" (8 MM)	1/4" (6 MM)
	✓		✓

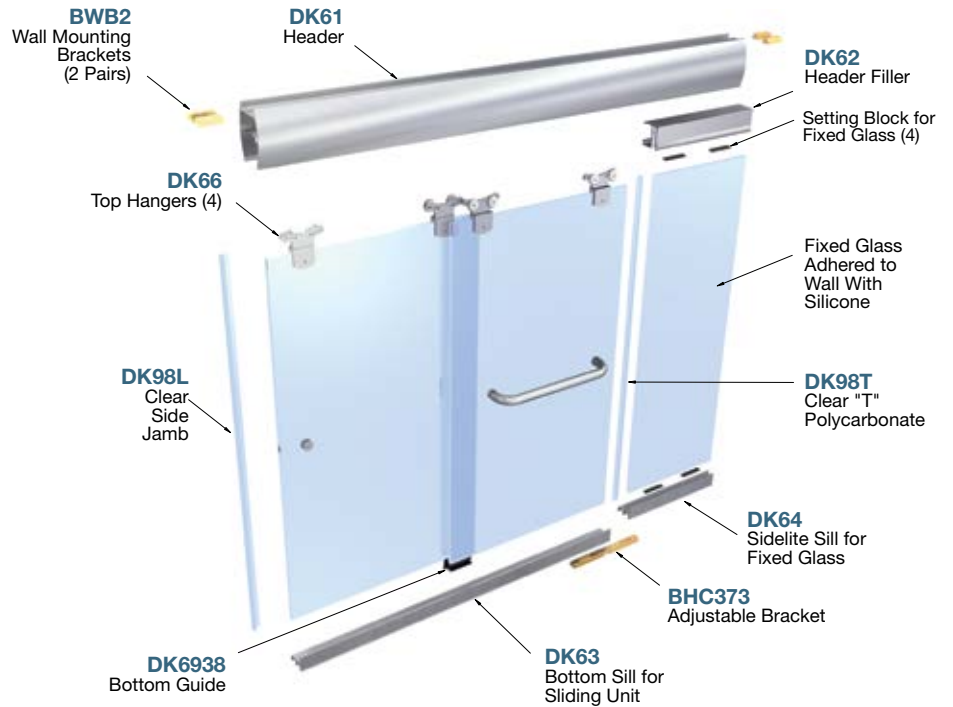

## CK SERIES WITH CLEAR SIDE JAMBS

- Typical View of a Custom Inline CK Series Shower Door Unit With Clear Side Jambs and an Adjacent Fixed Glass Panel on a Knee Wall
- Example Shown is for Use With 3/8" (10 mm) Tempered Glass

USE MONOLITHIC TEMPERED GLASS FOR GLASS THICKNESSES			
1/2" (12 MM)	3/8" (10 MM)	5/16" (8 MM)	1/4" (6 MM)
	✓		✓

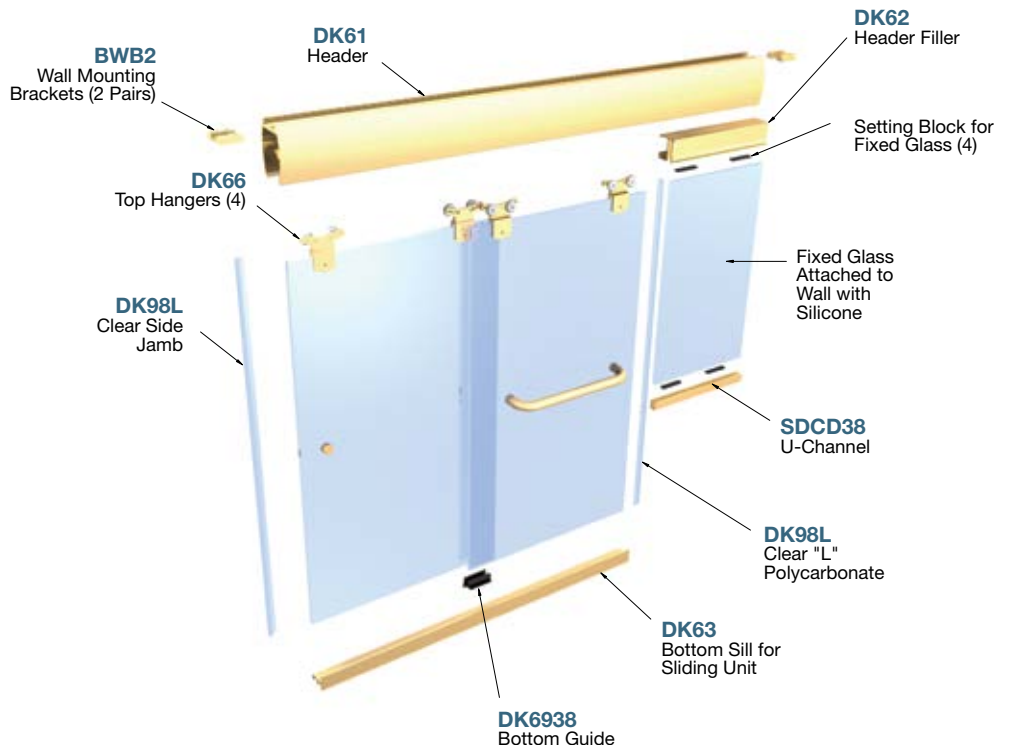

# COTTAGE DK SERIES TWO DOOR BYPASS FRAMELESS SLIDING SHOWER DOOR KITS

## DK SERIES WITH METAL JAMBS

- Utilizes Traditional Metal Side Jambs
- Bolt-Through Top Hangers Provided for Immediate Fabrication and Installation
- Designed for Use With 3/8" or 1/4" (10 or 6 mm) Tempered Glass
- Brite Anodized, Brite Gold Anodized, Brushed Nickel, and Oil Rubbed Bronze in Up to Six Stock Sizes
- Custom Units Also Available

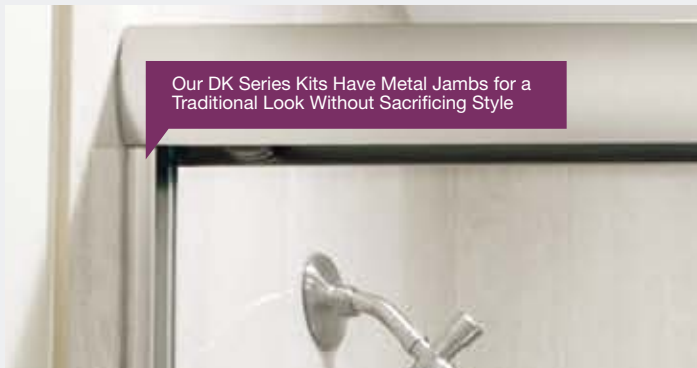

Our DK Series Kits Have Metal Jambs for a Traditional Look Without Sacrificing Style



Installed by Crystal Glass & Mirror Corp.

Cottage DK Series Sliders utilize metal side jambs for a traditional frameless sliding shower door appearance. Bolt-Through Top Hangers allow immediate fabrication and installation, with no waiting for messy adhesive to dry. Our DK Series Kits come in Brite Anodized, Brite Gold Anodized, Brushed Nickel, and Oil Rubbed Bronze finishes, with other finishes available on special order.

### FINISHES:



### SPECIFICATIONS:

**Materials:** Extrusions (Aluminum); Towel Bar (Brass Tubing); Knob (Solid Brass)  
**For Glass Thickness:** 3/8" or 1/4" (10 or 6 mm) – (Glass not included in Kit)  
**Glass Fabrication:** Towel Bar – Two 1/2" (12 mm) Diameter Holes, 24" (610 mm) Center-to-Center; Knob – One 1/2" (12 mm) Diameter Hole; Top Hangers – Four 1/2" (12 mm) Diameter Holes (two per glass panel)

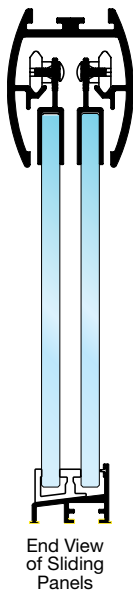

End View of Sliding Panels

The top hung stock units include: Extruded Aluminum Header, Side Jambs, and Bottom Sill; Top Hangers for 3/8" or 1/4" (10 or 6 mm) glass, Back-to-Back Knob, 24" (610 mm) Towel Bar, Nylon Rollers, Bottom Guide, Screws, and Bumpers. Tempered glass and silicone sealant are supplied by the installer to complete the installation. Since all rollers are overhead, the Bottom Sill and Side Jambs are uncluttered, making cleaning easy. They are available in up to six stock sizes. Extrusions, Bottom Guides, Hardware Packages, and other accessories may be ordered separately (see next page). Custom units are available for special installations.

USE MONOLITHIC TEMPERED GLASS FOR GLASS THICKNESSES			
1/2" (12 MM)	3/8" (10 MM)	5/16" (8 MM)	1/4" (6 MM)
	✓		✓



### COTTAGE DK SERIES SLIDING SHOWER DOOR KITS

FOR 3/8" (10 MM) GLASS CAT. NO.*	FOR 1/4" (6 MM) GLASS CAT. NO.*	SIZE (WIDTH X HEIGHT)
DK386060	DK146060	60" x 60" (1.52 m x 1.52 m)
DK386072	DK146072	60" x 72" (1.52 m x 1.83 m)
DK386080	---	60" x 80" (1.52 m x 2.03 m)
DK387260	DK147260	72" x 60" (1.83 m x 1.52 m)
DK387272	---	72" x 72" (1.83 m x 1.83 m)
DK387280	---	72" x 80" (1.83 m x 2.03 m)

\* Specify Finish When Ordering



# A COMPARISON OF COTTAGE SERIES FRAMELESS SLIDING SHOWER DOOR KITS

- Metal Side Jambs Make the DK Series Your Choice for a Traditionally Styled Enclosure

## DK SERIES WITH METAL SIDE JAMBS

- Typical View of a Custom Inline DK Series Shower Door Unit With Metal Side Jamb and an Adjacent Full Length Fixed Glass Panel
- Example Shown is for Use With 3/8" (10 mm) Tempered Glass

USE MONOLITHIC TEMPERED GLASS FOR GLASS THICKNESSES			
1/2" (12 MM)	3/8" (10 MM)	5/16" (8 MM)	1/4" (6 MM)
	✓		✓

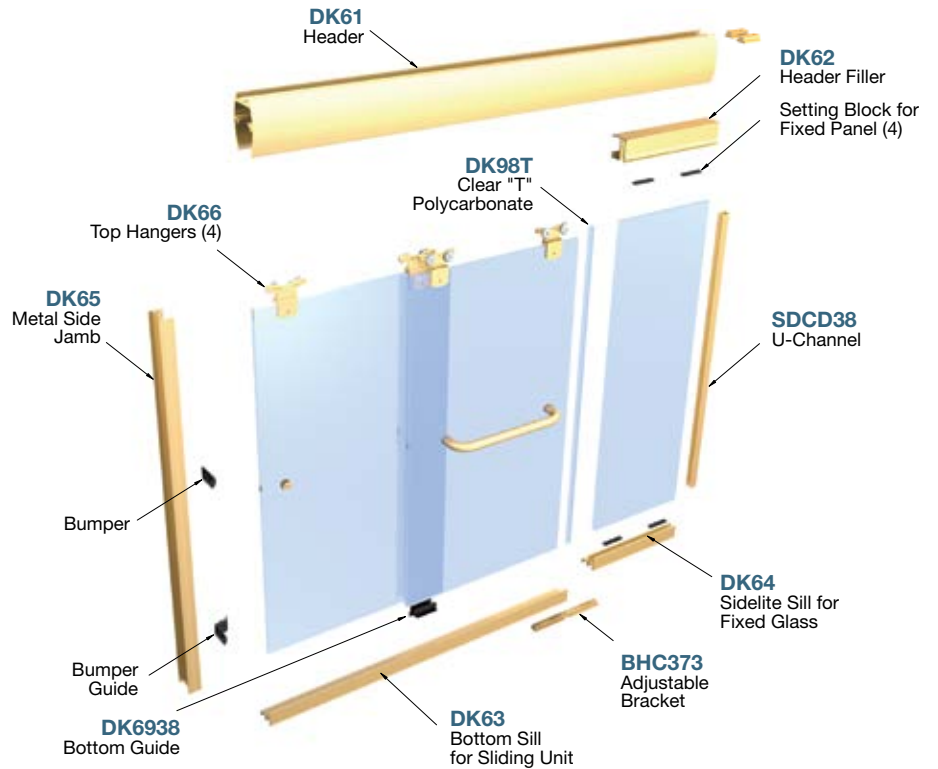

## DK SERIES WITH METAL SIDE JAMBS

- Typical View of a Custom Inline DK Series Shower Door Unit With Metal Side Jamb and an Adjacent Fixed Glass Panel on a Knee Wall
- Example Shown is for Use With 3/8" (10 mm) Tempered Glass

USE MONOLITHIC TEMPERED GLASS FOR GLASS THICKNESSES			
1/2" (12 MM)	3/8" (10 MM)	5/16" (8 MM)	1/4" (6 MM)
	✓		✓

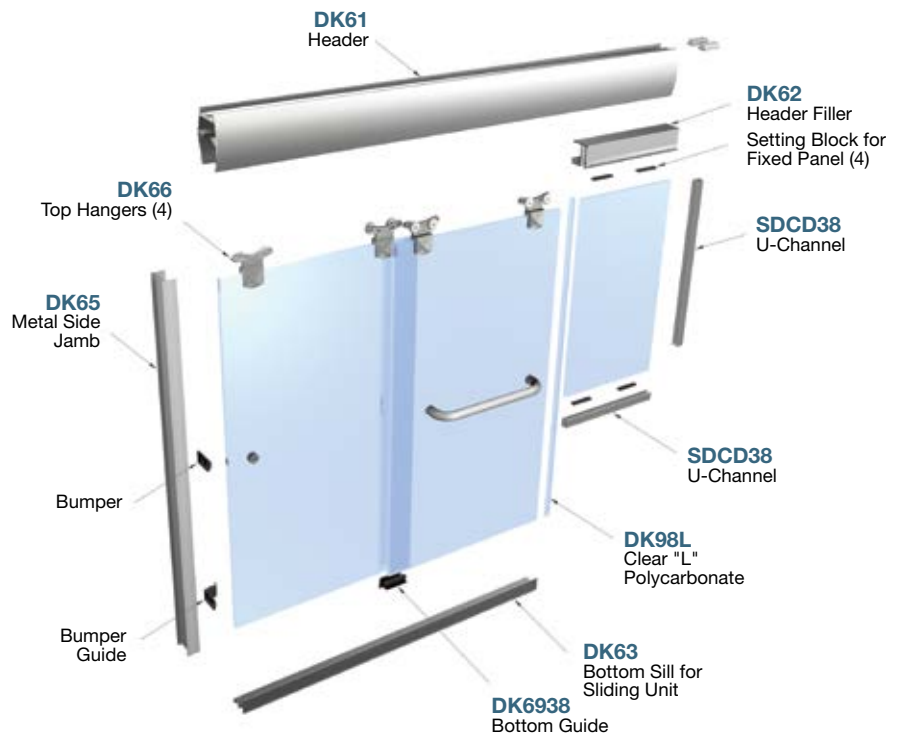

# SUITE EK SERIES TWO DOOR BYPASS FRAMELESS SLIDING SHOWER DOOR KITS

- Designed for Use With 1/4" (6 mm) Tempered Glass
- Clamp-On Hanger Bracket Eliminates Glass Drilling
- Offered Only in Inline Units With Metal Side Jambs
- Low Profile 2-9/16" (65 mm) Header is Reversible So You Can Expose Either the Curved or Flat Side
- Custom Finish Units Also Available

Our Suite Series Kits for Use With 1/4" (6 mm) Glass Have Many of the Fine Features Found in Our Cottage Series Shower Door Kits

**KITS INCLUDE:**



The Suite EK Series Frameless Sliding Shower Door Kit for 1/4" (6 mm) thick tempered safety glass provides an alternative design and mounting method to our Deluxe Cottage Series Sliders. The Hanger Bracket is a cost-reducing device, as it clamps directly onto the glass and eliminates the need for drilling holes (set screws only). The brackets allow for smooth, quiet operation and long service life at a lower cost.

**FINISHES:**



**SPECIFICATIONS:**

**Materials:** Extrusions (Aluminum); Towel Bar (Brass Tubing); Knob (Solid Brass)

**For Glass Thickness:** 1/4" (6 mm)  
(Glass not included in Kit)

**Glass Fabrication:** Towel Bar – Two 1/2" (12 mm) Diameter Holes, 24" (610 mm) Center-to-Center; Knob – One 1/2" (12 mm) Diameter Hole

**Maximum Recommended Size:**  
60" W x 72" H (1.52 m x 1.83 m)

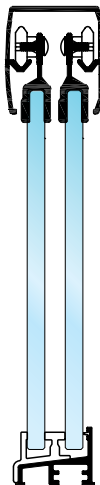

End View of Sliding Panels

The specially designed Header is only 2-9/16" (65 mm) tall. This reduces the visibility of the top metal, and allows more of the frameless, 'all-glass' look. It is reversible so the customer has the choice of using the gently curved side, or the flat side with top and bottom edge bevels.

The Suite EK Series is available exclusively with metal side jambs, does not offer the clear jamb system, and is available only for inline units. Kits with fixed panels are not available.

Two popular stock sizes are available: 60" W x 60" H (1.52 m x 1.52 m) and 60" W x 72" H (1.52 m x 1.83 m). The Suite EK Series comes in four popular finishes. Custom finishes are available upon request. Glass is not included in any EK Series Kit.

USE MONOLITHIC TEMPERED GLASS FOR GLASS THICKNESSES			
1/2" (12 MM)	3/8" (10 MM)	5/16" (8 MM)	1/4" (6 MM)
			✓



**SUITE EK SERIES SLIDING SHOWER DOOR KITS**

CAT. NO.*	SIZE (WIDTH X HEIGHT)
EK146060	60" x 60" (1.52 m x 1.52 m)
EK146072	60" x 72" (1.52 m x 1.83 m)

\* Specify Finish When Ordering



# MK SERIES TWO DOOR BYPASS FRAMELESS SLIDING SHOWER DOOR KITS

- Concealed Overhead Roller Design Allows Greater Glass Exposure With Less Exposed Metal
- Bonded Hanger System for Easy Installation
- Bolt-Through Hanger System Available on Special Order
- Custom Units Available

USE MONOLITHIC TEMPERED GLASS FOR GLASS THICKNESSES			
1/2" (12 MM)	3/8" (10 MM)	5/16" (8 MM)	1/4" (6 MM)
	✓		✓

**FINISHES:**



**SPECIFICATIONS:**

**Materials:** Extrusions (Aluminum); Towel Bar and Knob (Solid Aluminum)  
**For Glass Thickness:** 3/8" or 1/4" (10 or 6 mm) - Glass not included in Kit  
**Stock Kits Include:** Aluminum Extrusions, 24" (610 mm) Towel Bar, Knob, Hardware Package  
**Glass Fabrication:** Towel Bar - Two 1/2" (12 mm) Diameter Holes 24" (610 mm) Center-to-Center; Knob - One 1/2" (12 mm) Diameter Hole

Our MK Series Frameless Slider Kits provide all the extrusions (Header, Top Hanger Rails, Bottom Track, and Side Jambs) necessary for installation, as well as a Towel Bar, Knob, Rollers, Guide, and Installation Hardware. The glass and silicone sealant are supplied by the installer. The easy-to-clean Bottom Track utilizes a center-mounted guide. Available in custom sizes, configurations, and finishes on special order.



**MK SLIDER KITS FOR 3/8" (10 MM) GLASS**

CAT. NO.	SIZE (W X H)	FINISH
<a href="#">S386060BA</a>	60" x 60" (1.52 m x 1.52 m)	Brite Anodized
<a href="#">S386060BN</a>	60" x 60" (1.52 m x 1.52 m)	Brushed Nickel
<a href="#">S386072BA</a>	60" x 72" (1.52 m x 1.83 m)	Brite Anodized
<a href="#">S386072BN</a>	60" x 72" (1.52 m x 1.83 m)	Brushed Nickel

**MK SLIDER KITS FOR 1/4" (6 MM) GLASS**

CAT. NO.	SIZE (W X H)	FINISH
<a href="#">S146060BA</a>	60" x 60" (1.52 m x 1.52 m)	Brite Anodized
<a href="#">S146060BN</a>	60" x 60" (1.52 m x 1.52 m)	Brushed Nickel
<a href="#">S146072BA</a>	60" x 72" (1.52 m x 1.83 m)	Brite Anodized
<a href="#">S146072BN</a>	60" x 72" (1.52 m x 1.83 m)	Brushed Nickel

# MK SERIES REPLACEMENT PARTS AND ACCESSORIES

- Components Available Separately So You Can Build Your Own Units or Use for Replacement



**Header**  
3/8" (10 mm)

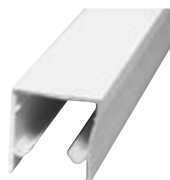

**Top Hanger Rail**  
1/4" (6 mm)

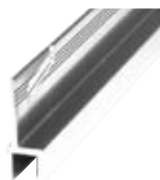

**Bottom Track**  
3/8" (10 mm)



**Side Jamb**  
1/4" (6 mm)



**Header**  
3/8" or 1/4" (10 or 6 mm)



**Top Hanger Rail**  
3/8" or 1/4" (10 or 6 mm)

**MK SERIES EXTRUSIONS AND ACCESSORIES FOR 3/8" (10 MM) GLASS**

FOR 3/8" (10 MM) GLASS CAT. NO.	DESCRIPTION	FINISH
<a href="#">H72BA</a>	72" (1.83 m) Header	Brite Anodized
<a href="#">H72BN</a>	72" (1.83 m) Header	Brushed Nickel
<a href="#">TR72BA</a>	72" (1.83 m) Top Hanger Rail	Brite Anodized
<a href="#">TR72BN</a>	72" (1.83 m) Top Hanger Rail	Brushed Nickel
<a href="#">BT72BA**</a>	72" (1.83 m) Bottom Track	Brite Anodized
<a href="#">BT72BN**</a>	72" (1.83 m) Bottom Track	Brushed Nickel
<a href="#">SJ72BA**</a>	72" (1.83 m) Side Jamb	Brite Anodized
<a href="#">SJ72BN**</a>	72" (1.83 m) Side Jamb	Brushed Nickel
<a href="#">HP38BA</a>	Hardware Package Only*	Brite Anodized
<a href="#">HP38BN</a>	Hardware Package Only*	Brushed Nickel

\*Hardware Package does not include Towel Bar or Knob.  
 \*\*The same Bottom Track and Side Jamb may be used for either 3/8" or 1/4" (10 or 6 mm) glass.

**MK SERIES EXTRUSIONS AND ACCESSORIES FOR 1/4" (6 MM) GLASS**

FOR 1/4" (6 MM) GLASS CAT. NO.	DESCRIPTION	FINISH
<a href="#">H7214BA</a>	72" (1.83 m) Header	Brite Anodized
<a href="#">H7214BN</a>	72" (1.83 m) Header	Brushed Nickel
<a href="#">TR7214BA</a>	72" (1.83 m) Top Hanger Rail	Brite Anodized
<a href="#">TR7214BN</a>	72" (1.83 m) Top Hanger Rail	Brushed Nickel
<a href="#">BT72BA**</a>	72" (1.83 m) Bottom Track	Brite Anodized
<a href="#">BT72BN**</a>	72" (1.83 m) Bottom Track	Brushed Nickel
<a href="#">SJ72BA**</a>	72" (1.83 m) Side Jamb	Brite Anodized
<a href="#">SJ72BN**</a>	72" (1.83 m) Side Jamb	Brushed Nickel
<a href="#">HP14BA</a>	Hardware Package Only*	Brite Anodized
<a href="#">HP14BN</a>	Hardware Package Only*	Brushed Nickel

\*Hardware Package does not include Towel Bar or Knob.  
 \*\*The same Bottom Track and Side Jamb may be used for either 3/8" or 1/4" (10 or 6 mm) glass.

# CLEAR SPACE™ TUB AND SHOWER ENCLOSURE SYSTEM

**NEW**

- Produces Large Opening While Utilizing Minimal Use of Floor Space
- Natural Feeling Elliptical Door Swing Motion
- Self-Closing and Self-Opening for Final 20 Degrees of Door Travel
- An Ideal Choice for Enclosures Used by Physically Challenged Individuals
- Can Also Be Used in 90 Degree and 135 Degree Fixed Panel Configurations

**FEATURES AND BENEFITS:**

- The perfect companion for assisting physically challenged individuals
- Produces large openings with minimal use of floor space
- Natural feeling elliptical door swing motion that does not move excessively towards the wheel chair
- Doors can be installed at both sides of an opening
- Can be configured with a pair of doors or with a fixed lite opposite the shower head
- Self-closing, self-opening for final 20 degrees of door swing
- Top Door Guide automatically hides and is unobtrusive at only 1-1/4" (32 mm) tall
- Many fixed lite configurations are compatible, like the ever popular 90 degree return and 135 degree neo angle
- Door swings inwardly with a normal pivoting action when a doorway jamb/stop is not used
- Compatible with bathtubs, raised curbs and flush floors
- Available optional header (call for details)



The **NEW** CLEAR SPACE™ is a state-of-the-art shower and bath enclosure system that is as functional as it is beautiful. An industry first elliptical door swing that gets out of the way, creating an open floor space on both sides of the enclosure! Large openings up to 72" (1829 mm) wide can result (based on a double door scenario), as the door projects only 10-1/2" (267 mm) into the enclosure, and 10-1/2"-16-1/2" (267- 419 mm) out from the enclosure, avoiding sinks, toilets, and shower valves in the open floor space. Natural pivot door operation enhances the user experience, producing door space efficiency, without a header! The Top Door Guide

automatically rotates open against the interior wall when the door is operated. CLEAR SPACE™ is the perfect companion for assisting physically challenged individuals, because the distance that the door travels toward the wheel chair is drastically reduced, and this is very important when producing wide openings. Natural pivot door operation and assisted opening/closing further enhances ergonomics while assuring that the door stays put in both positions.

**SPECIFICATIONS:**

- Material:** Solid Brass
- Glass Thickness:** 1/2" or 3/8" (12 or 10 mm)
- Maximum Door Size:** Using two hinges - 36" (914 mm) wide and 110 lbs (50 kg); Using three hinges - 36" (914 mm) wide and 140 lbs (63 kg) (Do not exceed either width or weight)
- Glass Fabrication Required for Hinges and Top Guide**

**EACH CLEAR SPACE™ KIT CONTAINS:**

- Two - Wall Mount Hinges
- Two - 180° Glass-to-Glass Hinges
- One - Control Arm (Left or Right)
- One - Top Guide

**NOTE:** For enclosures requiring three Wall Mount and three 180° Glass-to-Glass Hinges, those third hinges must be purchased separately.

**FINISHES:**

-  Polished Stainless Steel
-  Brushed Stainless Steel
-  **NEW** Matte Black
-  Chrome
-  Oil Rubbed Bronze

USE MONOLITHIC TEMPERED GLASS FOR GLASS THICKNESSES			
1/2" (12 MM)	3/8" (10 MM)	5/16" (8 MM)	1/4" (6 MM)
✓	✓		

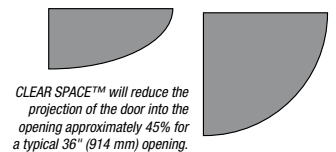

**CLEAR SPACE™ TUB AND SHOWER SYSTEM COMPLETE SWINGING KITS**

CAT. NO.	DESCRIPTION	FINISH
<b>CLSK1RCH</b>	Complete Right Hand Swinging Kit*▲	Polished Chrome
<b>CLSK1RBN</b>	Complete Right Hand Swinging Kit*▲	Brushed Nickel
<b>CLSK1RBR</b>	Complete Right Hand Swinging Kit*▲	Polished Brass
<b>CLSK1RORB</b>	Complete Right Hand Swinging Kit*▲	Oil Rubbed Bronze
<b>CLSK1RMBL</b>	Complete Right Hand Swinging Kit*▲	Matte Black
<b>CLSK1LCH</b>	Complete Left Hand Swinging Kit*▲	Polished Chrome
<b>CLSK1LBN</b>	Complete Left Hand Swinging Kit*▲	Brushed Nickel
<b>CLSK1LBR</b>	Complete Left Hand Swinging Kit*▲	Polished Brass
<b>CLSK1LORB</b>	Complete Left Hand Swinging Kit*▲	Oil Rubbed Bronze
<b>CLSK1LMBL</b>	Complete Left Hand Swinging Kit*▲	Matte Black

\* As viewed from outside of shower.  
▲ Complete kits contain two Wall Mount and two 180° Glass-to-Glass Hinges. For enclosures requiring three hinges, those hinges must be purchased separately.



# TRANSPARA™ **NEW** VERTICALLY FRAMELESS SHOWER DOOR SYSTEM

- Doors Shipped "Ready-to-Install"  
With Door Rails Factory Bonded to 3/8" (10 mm)  
Thick Tempered Glass
- Doors Rise 1/8" (3 mm) for Quiet Bottom Seal Operation
- Plus or Minus 1" (25 mm) Door Closing Position Adjustment
- Fixed Panels Supplied by CRL or Customer



**SPECIFICATIONS:**

**Door Glass Thickness:**  
3/8" (10 mm) Tempered Safety Glass  
(Included for Door Only)  
**Construction:** Extruded Aluminum  
**Door Swing:** Full Rotation  
**Closing Type:** Self Closing When  
Within 45 Degrees of Closed Position  
**No Cut-Out Required**

**Maximum Capacities:**  
Door Weight: 100 lbs/45 kg  
Door Width: 31"/787 mm  
(Do not exceed either Door  
Weight or Door Width)  
**Door Height:**  
96" (2438 mm)



The **NEW** Transpara™ Shower Door System offers a truly all-glass aesthetic by being able to handle large glass lites without the need for door hinges or vertical framing. This produces uninterrupted glass visuals that are further enhanced by sleek, low-profile door rails. Matching U-Channel (ordered separately, see below) on adjacent fixed panels maintains a continuous sightline across the entire enclosure.

Appearances can be deceiving; despite having minimal hardware, the thin frames come equipped with innovative performance features. They include a water management system that is integrated into the closing mechanism, and a four-component fitting that uses the weight of the door itself to close. The installer-friendly door comes factory pre-glazed, and requires only two screws to install the bottom pivot. With visible hardware being only 3/4" (19 mm) high, Transpara™ delivers the best in contemporary design.

## STOCK DOOR KITS AND CUSTOM KITS

**Ready-to-Install Stock Door Kit Includes:**

- Top Pivot
- Bottom Pivot Set with  
Mounting Fasteners and Expansion Anchors
- Top and Bottom Rails Bonded Onto the  
3/8" (10 mm) Glass Door, with Bushing  
Pre-installed in the Top Rail, and Pivot Pin and  
Self-Closing Mechanism in the Bottom Rail
- Four End Caps Bonded Into Place
- BM6X6 Model Tubular Back-to-Back  
Pull Handle

**Items Ordered Separately:**

- Fixed Panel Glass  
(By CRL or Customer)
- TRA1516UC Fixed Panel U-Channel
- TRAUC1 U-Channel End Caps
- Vertical Seals
- SQH980 Header and TRAHPR1  
Pivot Retainer Block (if necessary)

**FINISHES:**

-  Brite Anodized
-  Brite Gold Anodized
-  Brushed Nickel
-  Oil Rubbed Bronze



CAT. NO.	DESCRIPTION	FINISH
<a href="#">TRA2884BA</a>	28" x 84" (711 x 2134 mm) Stock Kit	Brite Anodized
<a href="#">TRA2884BGA</a>	28" x 84" (711 x 2134 mm) Stock Kit	Brite Gold Anodized
<a href="#">TRA2884BN</a>	28" x 84" (711 x 2134 mm) Stock Kit	Brushed Nickel
<a href="#">TRA2884ORB</a>	28" x 84" (711 x 2134 mm) Stock Kit	Oil Rubbed Bronze
<a href="#">TRAC1BA</a>	Custom Kit (Drawing Required)	Brite Anodized
<a href="#">TRAC1BGA</a>	Custom Kit (Drawing Required)	Brite Gold Anodized
<a href="#">TRAC1BN</a>	Custom Kit (Drawing Required)	Brushed Nickel
<a href="#">TRAC1ORB</a>	Custom Kit (Drawing Required)	Oil Rubbed Bronze

# LAGUNA SERIES SLIDING GLASS DOOR SYSTEMS WITH ANTI-LIFT SAFETY FEATURES

**NEW**

- **NEW** Optional “Softbrake” Braking System Assures Quiet Closing and Prevents Slamming
- Available in Brushed Stainless, Polished Stainless, or **NEW** Matte Black Finish
- Anti-Lift Feature for Added Safety
- 316 Grade Stainless Steel Construction for Durability
- Comes With Fasteners Needed for Either Flush (Countersunk) or Surface (Straight Hole) Mounting



**NEW** “Softbrake” Kits For Soft Closing



**NEW** Anti-Lift Double Top Roller For Contemporary Design



Anti-Lift Single Top Roller



Installed by SouthShore Shower Door

CRL has expanded the popular Laguna Series Sliding Glass Door line to include optional “Softbrake” Kits and Double Top Roller Kits. In addition, all kits are now available in either Brushed Stainless or Polished Stainless Finishes, and our most popular kits come in Matte Black. The **NEW** “Softbrake” option, for wall mounted kits, provides a controlled, quiet closure and prevents the doors from “slamming” open or closed. The **NEW** finish option, and **NEW** Double Top Rollers give you a variety of aesthetically pleasing options to accommodate the most imaginative designers.

The Laguna Series Sliding Glass Door System can be installed on glass partitions or directly to the side of a sufficiently reinforced wall. The adjustable Top Rollers make final adjustments quick and easy, without the need to remove the door. Their smooth operation and solid stainless steel construction minimizes maintenance issues.

CRL provides you with all the glass attachment fasteners for either flush mounting (requiring a countersunk hole), or surface mounting (requiring a straight hole). The glass attachment fasteners accommodate either 3/8" or 1/2" (10 or 12 mm) tempered glass and can easily be secured using our Cat. No. SW19 or LSSW1 Spanner Head Wrenches.

Standardized sets allow you to make planning and purchasing quick and easy for basic installations. We offer a wide variety of kits for Wall Mounting or Glass Mounting. We also offer an Adapter Kit, Cat. No. LSWMADT, to convert these Laguna Kits for use with wood doors.

For more information go to [crlaurence.com/sliding-glass-doors](http://crlaurence.com/sliding-glass-doors) or contact CRL Technical Sales at (800) 421-6144 in the U.S., (877) 421-6144 from Canada, or (323) 588-1281 International, and ask for Ext. 7740. You can also send e-mail to [showers@crlaurence.com](mailto:showers@crlaurence.com).

USE MONOLITHIC TEMPERED GLASS FOR GLASS THICKNESSES			
1/2" (12 MM)	3/8" (10 MM)	5/16" (8 MM)	1/4" (6 MM)
✓	✓		

**FINISHES:**

-  Polished Stainless Steel
-  Brushed Stainless Steel
-  **NEW** Matte Black

**DOOR SYSTEM LIMITATIONS**

Maximum Door Weight	220 lbs. (100 kg)
Minimum Door Width	37-13/16" (960 mm)
Maximum Door Width	53-9/16" (1.36 m)
Maximum Door Height	98-7/16" (2.50 m)
Maximum Track Length	240" (6.1 m)

**NOTE:** Laminated glass cannot be used in these systems.

## LAGUNA SERIES GLASS MOUNT SINGLE SLIDER KIT WITH SINGLE TOP ROLLERS

- Kits Available in Brushed Stainless, Polished Stainless, or **NEW** Matte Black Finish
- Assembly Contains All Necessary Hardware to Complete Installation
- 316 Grade Stainless Steel Construction
- Improved Anti-Lift Design for Added Safety
- All Kits Include Fasteners Needed for Either Flush (Countersunk) or Surface (Straight Hole) Mounting

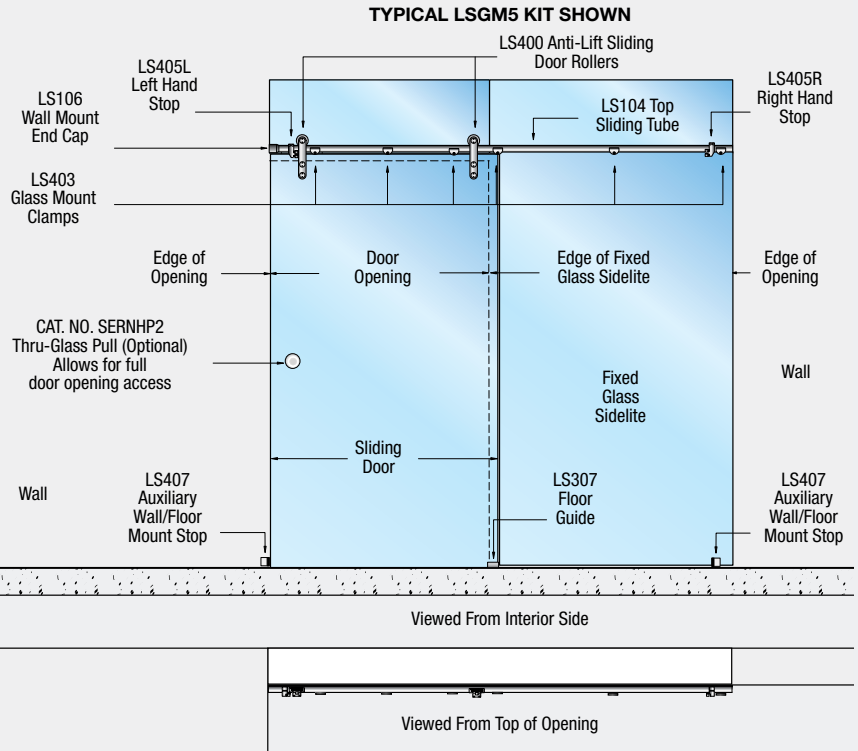

USE MONOLITHIC TEMPERED GLASS FOR GLASS THICKNESSES			
1/2" (12 MM)	3/8" (10 MM)	5/16" (8 MM)	1/4" (6 MM)
✓	✓		

**SINGLE TOP ROLLER KITS**

CAT. NO.	FINISH
LSGM5BS	Brushed Stainless
LSGM5PS	Polished Stainless
LSGM5MBL	Matte Black

*Must ship common carrier.*

**DOOR SYSTEM LIMITATIONS**

Maximum Door Weight	220 lbs. (100 kg)
Minimum Door Width	37-13/16" (960 mm)
Maximum Door Width	53-9/16" (1.36 m)
Maximum Door Height	98-7/16" (2.50 m)

The Laguna Series Glass Mount Single Slider Kit contains all the components you will need (except the tempered glass) to complete this style of installation. This model is used in applications where you are attaching a single sliding door in an 'all-glass' opening where you have a wall on one end next to the door, a glass transom above the door, and a fixed glass panel on the other side of the door. Bi-parting double doors are not possible for this application.

The Anti-Lift Sliding Door Single Top Rollers can be attached to the glass with either Surface Mount or Flush Mount Fittings (both are supplied). The Rollers have a 1/8" (3 mm) up or down vertical adjustment to aid in door alignment. Complete glass fabrication details and drawings are available from [crlaurence.com/sliding-glass-doors](http://crlaurence.com/sliding-glass-doors). **NOTE:** This system should only be used with 1/2" or 3/8" (12 or 10 mm) tempered glass. Laminated glass cannot be used.

**EACH KIT CONTAINS:**



(6) LS403 Top Sliding Tube Glass Mount Clamps



(2) LS407 Auxiliary Wall/Floor Mount Door Stops



(2) LS405 Door Stops (One Left Hand and One Right Hand)



(1) LS307 Bottom Floor Guides



(1) LS104 Top Sliding Tube at 104" (2.64 m) in Length With End Caps



(1) LS106 Top Sliding Tube Wall Mount End Cap (Fastener to Wall is Not Included)



(2) LS400 Anti-Lift Top Rollers



**LAGUNA SERIES GLASS MOUNT SINGLE SLIDER KIT WITH DOUBLE TOP ROLLERS**

- **NEW** Double Top Rollers for Contemporary Design
- Kits Available in Brushed Stainless, Polished Stainless, or **NEW** Matte Black Finish
- Assembly Contains All Necessary Hardware to Complete Installation
- 316 Grade Stainless Steel Construction
- Anti-Lift Design for Added Safety
- All Kits Include Fasteners Needed for Either Flush (Countersunk) or Surface (Straight Hole) Mounting

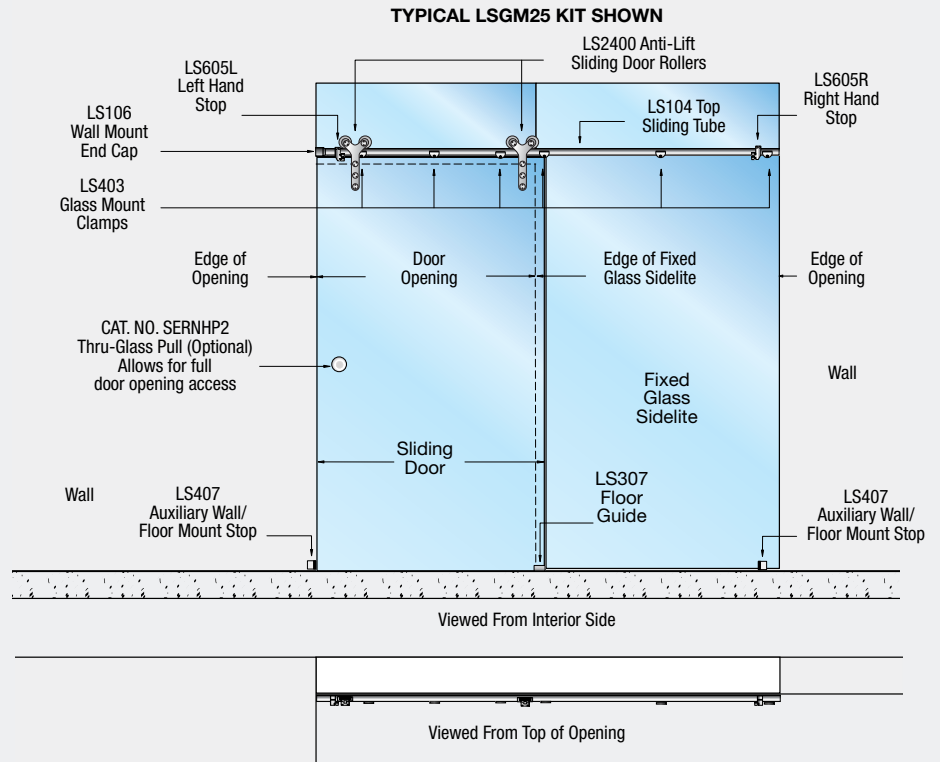

USE MONOLITHIC TEMPERED GLASS FOR GLASS THICKNESSES

1/2" (12 MM)	3/8" (10 MM)	5/16" (8 MM)	1/4" (6 MM)
✓	✓		

DOUBLE TOP ROLLER KITS	
CAT. NO.	FINISH
LSGM25BS	Brushed Stainless
LSGM25PS	Polished Stainless
LSGM25MBL	Matte Black

Must ship common carrier.

DOOR SYSTEM LIMITATIONS	
Maximum Door Weight	220 lbs. (100 kg)
Minimum Door Width	37-13/16" (960 mm)
Maximum Door Width	53-9/16" (1.36 m)
Maximum Door Height	98-7/16" (2.50 m)

The Laguna Series Glass Mount Single Slider Kit contains all the components you will need (except the tempered glass) to complete this style of installation. This model is used in applications where you are attaching a single sliding door in an 'all-glass' opening where you have a wall on one end next to the door, a glass transom above the door, and a fixed glass panel on the other side of the door. Bi-parting double doors are not possible for this application.

The Anti-Lift Sliding Door Double Top Rollers can be attached to the glass with either Surface Mount or Flush Mount Fittings (both are supplied). The Rollers have a 1/8" (3 mm) up or down vertical adjustment to aid in door alignment. Complete glass fabrication details and drawings are available from [crlaurence.com/sliding-glass-doors](http://crlaurence.com/sliding-glass-doors). **NOTE:** This system should only be used with 1/2" or 3/8" (12 or 10 mm) tempered glass. Laminated glass cannot be used.

**EACH KIT CONTAINS:**





## LAGUNA SERIES GLASS MOUNT SINGLE SLIDER WITH SIDELITES AND SINGLE TOP ROLLERS KIT

- Kits Available in Brushed Stainless, Polished Stainless, or Matte Black Finish
- Assembly Contains All Necessary Hardware to Complete Installation
- 316 Grade Stainless Steel Construction
- Anti-Lift Design for Added Safety
- All Kits Include Fasteners Needed for Either Flush (Countersunk) or Surface (Straight Hole) Mounting

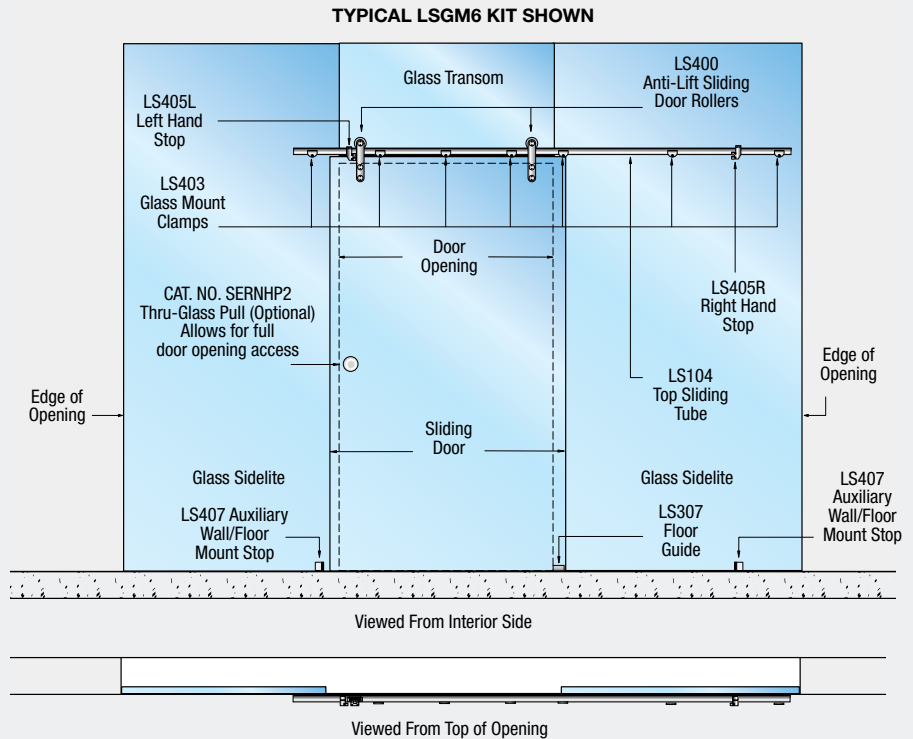

USE MONOLITHIC TEMPERED GLASS FOR GLASS THICKNESSES			
1/2" (12 MM)	3/8" (10 MM)	5/16" (8 MM)	1/4" (6 MM)
✓	✓		

### SINGLE TOP ROLLER KITS

CAT. NO.	FINISH
LSGM6BS	Brushed Stainless
LSGM6PS	Polished Stainless
LSGM6MBL	Matte Black

Must ship common carrier.

### DOOR SYSTEM LIMITATIONS

Maximum Door Weight	220 lbs. (100 kg)
Minimum Door Width	37-13/16" (960 mm)
Maximum Door Width	53-9/16" (1.36 m)
Maximum Door Height	98-7/16" (2.50 m)

The Laguna Series Glass Mount Single Slider Kit contains all the components you will need (except the tempered glass) to complete this style of installation. This model is used in applications where you are attaching a single sliding door in an 'all-glass' opening and have a glass transom above the door and fixed glass panels on both sides of the door. Bi-parting double doors are not possible for this application.

The Anti-Lift Sliding Door Single Top Rollers can be attached to the glass with either Surface Mount or Flush Mount Fittings (both are supplied). The Rollers have a 1/8" (3 mm) up or down vertical adjustment to aid in door alignment. Complete glass fabrication details and drawings are available from [crlaurence.com/sliding-glass-doors](http://crlaurence.com/sliding-glass-doors). **NOTE:** This system should only be used with 1/2" or 3/8" (12 or 10 mm) tempered glass. Laminated glass cannot be used.

### EACH KIT CONTAINS:





**LAGUNA SERIES GLASS MOUNT SINGLE SLIDER WITH SIDELITES AND DOUBLE TOP ROLLERS KIT**

- **NEW** Double Top Rollers for Contemporary Design
- Kits Available in Brushed Stainless, Polished Stainless, or **NEW** Matte Black Finish
- Assembly Contains All Necessary Hardware to Complete Installation
- 316 Grade Stainless Steel Construction
- Anti-Lift Design for Added Safety
- All Kits Include Fasteners Needed for Either Flush (Countersunk) or Surface (Straight Hole) Mounting

TYPICAL LSGM26 KIT SHOWN

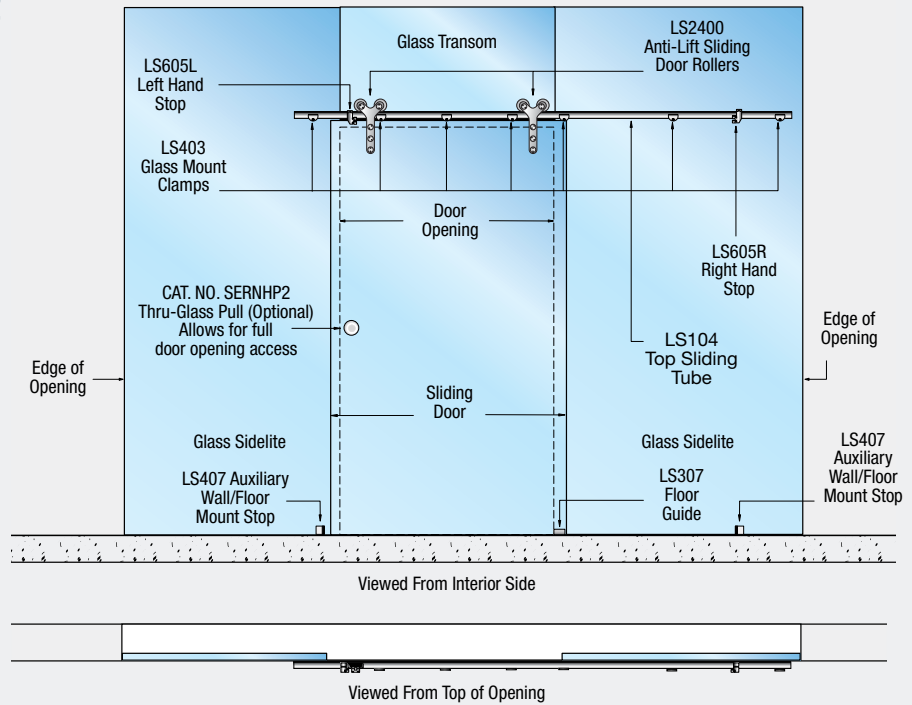

USE MONOLITHIC TEMPERED GLASS FOR GLASS THICKNESSES			
1/2" (12 MM)	3/8" (10 MM)	5/16" (8 MM)	1/4" (6 MM)
✓	✓		

DOUBLE TOP ROLLER KITS	
CAT. NO.	FINISH
LSGM26BS	Brushed Stainless
LSGM26PS	Polished Stainless
LSGM26MBL	Matte Black

DOOR SYSTEM LIMITATIONS	
Maximum Door Weight	220 lbs. (100 kg)
Minimum Door Width	37-13/16" (960 mm)
Maximum Door Width	53-9/16" (1.36 m)
Maximum Door Height	98-7/16" (2.50 m)

Must ship common carrier.

The Laguna Series Glass Mount Single Slider Kit contains all the components you will need (except the tempered glass) to complete this style of installation. This model is used in applications where you are attaching a single sliding door in an 'all-glass' opening and have a glass transom above the door and fixed glass panels on both sides of the door. Bi-parting double doors are not possible for this application.

The Anti-Lift Sliding Door Double Top Rollers can be attached to the glass with either Surface Mount or Flush Mount Fittings (both are supplied). The Rollers have a 1/8" (3 mm) up or down vertical adjustment to aid in door alignment. Complete glass fabrication details and drawings are available from [crlaurence.com/sliding-glass-doors](http://crlaurence.com/sliding-glass-doors). **NOTE:** This system should only be used with 1/2" or 3/8" (12 or 10 mm) tempered glass. Laminated glass cannot be used.

EACH KIT CONTAINS:





Installed by **Cyrstal Glass & Mirror Corp.**



Installed by **Elite Glass & Mirror**

TO SEE MORE BEAUTIFUL SHOWERS,  
LOG ON TO **CRLAURENCE.COM/GALLERY**  
AND VISIT OUR SHOWER GALLERY.



Installed by **Liberty Glass & Mirror**



Installed by **SouthShore Shower Door**

# DESIGNER GRAB BARS

- 1-1/4" (32 mm) Diameter Rounded and Square Profiles
- Covers Snap Over Mounting Flanges to Hide Screws
- Mount to Wall of Shower Interior (Not Glass)
- Stainless Steel Construction for Added Durability
- Six Models in Two Sizes and Three Finishes

**NEW**

**SPECIFICATIONS:**

**Material:** 1-1/4" (32 mm) Diameter Round or Square Stainless Steel Tubing

**Includes:** Cover Flanges and All Necessary Mounting Hardware

**No Glass Mounting:** Bars are Mounted to Surface of Interior Shower Wall

**FINISHES:**



Polished Stainless    Brushed Stainless    Matte Black

*Stocked in the finishes shown here, other finishes are available on special order.*



Installed by American Frameless

CAT. NO.	CENTER-TO-CENTER MOUNTING POINTS	OVERALL LENGTH	DESCRIPTION
<b>GBA18</b>	18" (457 mm)	25-1/2" (648 mm)	Straight Round Grab Bar
<b>GBA24</b>	24" (610 mm)	31-1/2" (800 mm)	Straight Round Grab Bar
<b>GBB18</b>	18" (457 mm)	19-1/4" (489 mm)	Mitered Round Grab Bar
<b>GBB24</b>	24" (610 mm)	25-1/4" (641 mm)	Mitered Round Grab Bar
<b>GBC18</b>	18" (457 mm)	23-5/8" (600 mm)	'S' Round Grab Bar
<b>GBC24</b>	24" (610 mm)	29-5/8" (752 mm)	'S' Round Grab Bar
<b>GBD18</b>	18" (457 mm)	25-1/2" (648 mm)	Straight Square Grab Bar
<b>GBD24</b>	24" (610 mm)	31-1/2" (800 mm)	Straight Square Grab Bar
<b>GBE18</b>	18" (457 mm)	19-1/4" (489 mm)	Mitered Square Grab Bar
<b>GBE24</b>	24" (610 mm)	25-1/4" (641 mm)	Mitered Square Grab Bar
<b>GBF18</b>	18" (457 mm)	23-5/8" (600 mm)	'S' Square Grab Bar
<b>GBF24</b>	24" (610 mm)	29-5/8" (752 mm)	'S' Square Grab Bar

*U-Channel or Glass Clamps for fixed panels must be ordered separately.*

Our **NEW** Grab Bars provide leverage and support for those moments in your shower or tub when you need a little assistance. These decorative Grab Bars are the perfect addition to any bathroom decor. They add confidence and security, while at the

same time adding style. Available in both 1-1/4" (32 mm) diameter round or square stainless steel tubing. The decorative covers fit securely over the Grab Bar mounting hardware, concealing the screws. All necessary mounting hardware is included.

**CAT. NO. GBA18** 18" Size  
**CAT. NO. GBA24** 24" Size

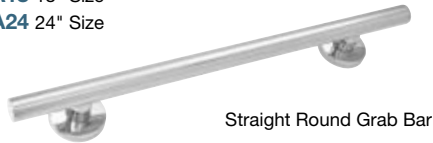

Straight Round Grab Bar

**CAT. NO. GBD18** 18" Size  
**CAT. NO. GBD24** 24" Size

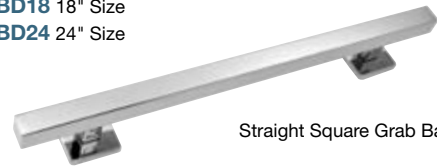

Straight Square Grab Bar

**CAT. NO. GBB18** 18" Size  
**CAT. NO. GBB24** 24" Size

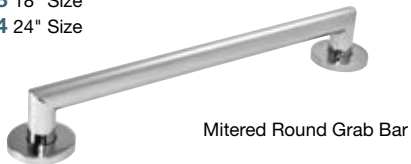

Mitered Round Grab Bar

**CAT. NO. GBE18** 18" Size  
**CAT. NO. GBE24** 24" Size

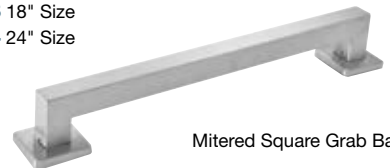

Mitered Square Grab Bar

**CAT. NO. GBC18** 18" Size  
**CAT. NO. GBC24** 24" Size



'S' Round Grab Bar

**CAT. NO. GBF18** 18" Size  
**CAT. NO. GBF24** 24" Size

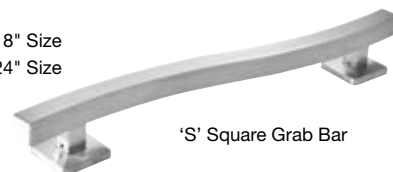

'S' Square Grab Bar

# POPULAR HANDLES, KNOBS, AND TOWEL BARS

## BM SERIES SINGLE-SIDED TOWEL BAR WITHOUT METAL WASHERS

- Low Profile End Caps Make This Towel Bar Ideal for Bypass Sliding Doors

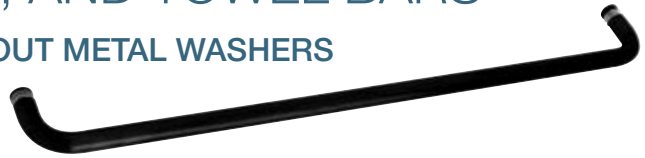

**SPECIFICATIONS:**

**Material:**  
3/4" (19 mm) Diameter Brass Tubing

**Glass Thickness Range:**  
1/2", 3/8", 5/16", or 1/4"  
(12, 10, 8, or 6 mm)

**Hole Diameter Required:**  
1/2" (12 mm)

**Center-to-Center Hole Spacing:**  
12" Towel Bar = 12" (305 mm)  
18" Towel Bar = 18" (457 mm)  
20" Towel Bar = 20" (508 mm)  
22" Towel Bar = 22" (559 mm)  
24" Towel Bar = 24" (610 mm)  
26" Towel Bar = 26" (660 mm)  
27" Towel Bar = 27" (686 mm)  
28" Towel Bar = 28" (711 mm)  
30" Towel Bar = 30" (762 mm)

**Projection From Glass Surface:**  
2-1/2" (64 mm)

**AVAILABLE SIZES:**

- |                                      |                                      |                                      |
|--------------------------------------|--------------------------------------|--------------------------------------|
| <b>CAT. NO. BMNW12</b> 12" Towel Bar | <b>CAT. NO. BMNW22</b> 22" Towel Bar | <b>CAT. NO. BMNW27</b> 27" Towel Bar |
| <b>CAT. NO. BMNW18</b> 18" Towel Bar | <b>CAT. NO. BMNW24</b> 24" Towel Bar | <b>CAT. NO. BMNW28</b> 28" Towel Bar |
| <b>CAT. NO. BMNW20</b> 20" Towel Bar | <b>CAT. NO. BMNW26</b> 26" Towel Bar | <b>CAT. NO. BMNW30</b> 30" Towel Bar |

The BM Series Single-Sided Towel Bar Without Metal Washers is designed for glass mounting on fixed panels or doors. The 1/8" (3 mm) low profile end caps make this an ideal bar for sliding bypass doors as well. The bars are constructed of 1.5 mil thick heavy brass tubing. Plastic washers protect against glass-to-metal contact.

**FINISHES:**



Stocked in the finishes shown here, other finishes are available on special order.

## SQ SERIES SQUARE CORNER SINGLE-SIDED TOWEL BAR

**SPECIFICATIONS:**

**Material:**  
3/4" (19 mm) Brass Tubing

**Glass Thickness Range:**  
1/2", 3/8", 5/16", or 1/4"  
(12, 10, 8, or 6 mm)

**Hole Diameter Required:**  
1/2" (12 mm)

**Center-to-Center Hole Spacing:**  
18" (457 mm); 24" (610 mm)

**Projection From Glass Surface:**  
2-1/2" (64 mm)



**Cat. No. SDK270**  
Square Single-Sided Knob Adapter. It can be used to make them into a Towel Bar and Knob Combination.



These sharp looking SQ Series Square Corner Single-Sided Towel Bars offer the clean and modern style that many designers prefer. They perfectly complement numerous CRL Hinge Series with similar corner style, such as Geneva, Vienna, Victoria, Melbourne, Concord, Cardiff, and others.

**FINISHES:**



Stocked in the finishes shown here, other finishes are available on special order.

**AVAILABLE SIZES:**

- CAT. NO. SQ18**  
18" Towel Bar
- CAT. NO. SQ24**  
24" Towel Bar

## TOWEL BAR/KNOB COMBINATIONS

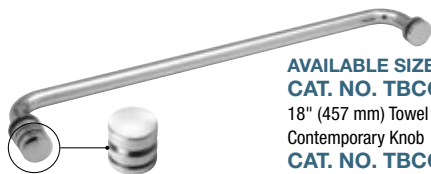

Contemporary Knob

**AVAILABLE SIZES:**  
**CAT. NO. TBCC18**  
18" (457 mm) Towel Bar With Contemporary Knob  
**CAT. NO. TBCC24**  
24" (610 mm) Towel Bar With Contemporary Knob



Traditional Knob

**AVAILABLE SIZES:**  
**CAT. NO. TBCT18**  
18" (457 mm) Towel Bar With Traditional Knob  
**CAT. NO. TBCT24**  
24" (610 mm) Towel Bar With Traditional Knob

**SPECIFICATIONS:**

**Material:**  
Towel Bar 3/4" (19 mm) Diameter Brass Tubing, 1-1/4" (32 mm) Diameter Metal Washers; Knob is Solid Brass

**Glass Thickness Range:**  
1/2", 3/8", 5/16", or 1/4"  
(12, 10, 8, or 6 mm)

**Hole Diameter Required:**  
1/2" (12 mm)

**Center-to-Center Hole Spacing:**  
18" Towel Bar = 18" (457 mm)  
24" Towel Bar = 24" (610 mm)

**Projection From Glass Surface:**  
2-1/2" (64 mm) for Towel Bar.  
Contemporary Knob is 1-3/16" (30 mm)  
Traditional Knob is 1" (25 mm)

Our Towel Bar/Knob Combinations allow the flexibility of design that appeals to many homeowners, designers, and architects. The Towel Bars are constructed of tubular brass, thus keeping lighter weight hardware installed on the door. The Knobs are constructed of solid brass, with a choice of CRL's popular Contemporary or Traditional Styles. Decorative metal washers are included, with plastic washers to protect against glass-to-metal contact. Stocked in nine standard finishes, with custom finishes available upon request.

**FINISHES:**

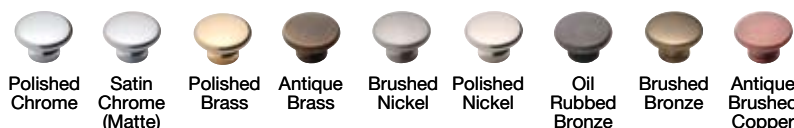

Stocked in the finishes shown here, other finishes are available on special order.

**NOTE:** Due to the wide variety of Towel Bars and Knobs that CRL stocks, it may be possible for you to construct the Towel Bar/Knob Combo you desire by purchasing separate component parts. In addition to the stock catalog numbers shown here, many CRL Knobs can thread into our Towel Bars. Call our Frameless Shower Technical Sales Department for assistance.



# POPULAR HANDLES, KNOBS, AND TOWEL BARS

## BM SERIES BACK-TO-BACK TUBULAR PULL HANDLE WITH METAL WASHERS

• Our Most Popular Handle

**SPECIFICATIONS:**

- Material:**  
3/4" (19 mm) Diameter Brass or Stainless Steel Tubing (1.5 mil thick)  
**Glass Thickness Range:**  
1/2", 3/8", 5/16", or 1/4"  
(12, 10, 8, or 6 mm)  
**Hole Diameter Required:**  
1/2" (12 mm)  
**Center-to-Center Hole Spacing:**  
6" (152 mm); 8" (203 mm)  
**Projection From Glass Surface:**  
2-1/2" (64 mm)

**FINISHES:**

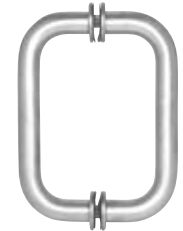

**CAT. NO. BM8X8**  
8" (203 mm) Size



**CAT. NO. BM6X6**  
6" (152 mm) Size

The BM Series Back-to-Back Tubular Pull Handle With Metal Washers is constructed of 1.5 mil thick heavy brass or stainless steel tubing. Decorative metal back-up washers are included, as well as plastic washers to protect against glass-to-metal contact. Consists of one pull for each side of the door (back-to-back), and come in 6" and 8" (152 and 203 mm) sizes.

## SQ SERIES SQUARE CORNER BACK-TO-BACK PULL HANDLE

**SPECIFICATIONS:**

- Material:**  
3/4" (19 mm) Brass Tubing  
**Glass Thickness Range:**  
1/2", 3/8", 5/16", or 1/4"  
(12, 10, 8, or 6 mm)  
**Hole Diameter Required:**  
1/2" (12 mm)  
**Center-to-Center Hole Spacing:**  
6" (152 mm); 8" (203 mm)  
**Projection From Glass Surface:**  
2-1/2" (64 mm)

**FINISHES:**

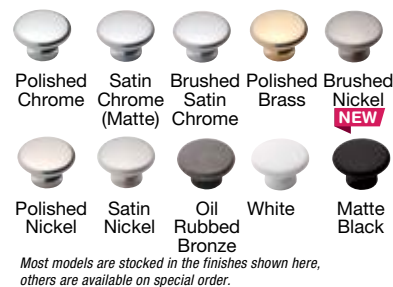

**CAT. NO. SQ6X6**  
6" (152 mm) Size



**CAT. NO. SQ8X8**  
8" (203 mm) Size

The sharp looking SQ Series Square Corner Handle gives the clean and traditional look that many designers prefer. This Handle perfectly complements numerous CRL Hinge Series with similar corner styles, such as Geneva, Vienna, Victoria, Melbourne, Concord, Cardiff, and others. Back-up plastic washers and nylon spacers are included to protect against glass-to-metal contact.

## "PEEL AND STICK" FINGER PULLS FOR SLIDING DOORS

- Two Attractive Models for Sliding Shower Doors
- Pulls Allow Door Travel With Finger Tip Ease
- Simply Peel The Included Double-Sided Tape and Adhere to Clean Glass
- Constructed of Stainless Steel in a Choice of Polished and Brushed Finishes

CAT. NO.	MODEL	FINISH
SLD1BS	Slim	Brushed Stainless
SLD1PS	Slim	Polished Stainless
SLD2BS	Recessed	Brushed Stainless
SLD2PS	Recessed	Polished Stainless

When wanting to avoid the extra cost of hole drilling for handles or knobs used for a sliding door, these "Peel and Stick" Finger Pulls provide an outstanding alternative. Two attractive options are offered, including a Slim Model and a Recessed Model. Finger Pulls come with double-sided clear tape included, making installation as easy as peel and stick. The glass should be clean and dry for optimal adhesion. Attractive polished or brushed stainless steel Finger Pulls will match or accent a great number of popular sliding shower door hardware finishes.



Slim Model



Recessed Model



# POPULAR HANDLES, KNOBS, AND TOWEL BARS

## TRADITIONAL STYLE BACK-TO-BACK AND SINGLE-SIDED KNOBS

**NEW** MATTE BLACK FINISH

**SPECIFICATIONS:**

**Material:** Solid Brass

**Available Finishes:** Polished Brass, Polished Chrome, Satin Brass, Satin Chrome (Matte), Brushed Satin Chrome, Gold Plated, Gun Metal, Polished Nickel, Brushed Nickel, Satin Nickel, Oil Rubbed Bronze, Antique Bronze, Brushed Bronze, Antique Brass, Ultra Brass, Antique Brushed Nickel, Polished Copper, Brushed Copper, Antique Brushed Copper, White, Black, and Matte Black

**Glass Thickness Range:**

1/2", 3/8", 5/16", or 1/4" (12, 10, 8, or 6 mm)

**Hole Diameter Required:** 1/2" (12 mm)

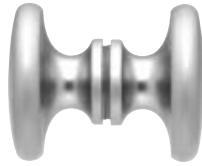

**CAT. NO. SDK100**  
Back-to-Back Knob



**CAT. NO. SDK200**  
Single-Sided Knob



Our solid brass Traditional Style Knobs are available in over 20 popular finishes. Overall diameter of knob is 1-9/16" (40 mm), overall height is 1" (25 mm) from glass. End cap for Single-Sided Knob stands 1/4" (6 mm) from the door surface.

## SQUARE STYLE BACK-TO-BACK KNOB

**NEW** MATTE BLACK FINISH

**SPECIFICATIONS:**

**Material:** Solid Brass

**Available Finishes:** Polished Brass, Polished Chrome, Satin Chrome (Matte), Brushed Nickel, Oil Rubbed Bronze and Matte Black

**Glass Thickness Range:** 1/2", 3/8", 5/16", and 1/4" (12, 10, 8, and 6 mm)

**Hole Diameter Required:** 1/2" (12 mm)



**CAT. NO. SDK160**  
Back-to-Back Knob

The solid brass Square Style Knob will be a favorite of architects, designers, and homeowners who wish to match the square cornered construction of such popular CRL Hinges as the Geneva, Vienna, Victoria, Melbourne, Concord, Cardiff, and Junior Geneva Series. The ribbed appearance will add to the appeal and create a beautifully aesthetic appearance. The Square Style Knob measures 1-3/16" (30 mm) across and stands 1-3/16" (30 mm) from the surface of the glass.

## CYLINDER STYLE BACK-TO-BACK AND SINGLE-SIDED KNOBS

**NEW** MATTE BLACK FINISH

• Models Offered With Protective Plastic Sleeve

**SPECIFICATIONS:**

**Material:**

Solid Brass

**Available Finishes:**

Polished Brass, Polished Chrome, Satin Brass, Satin Chrome (Matte), Brushed Satin Chrome, Brushed Nickel, Polished Nickel, Oil Rubbed Bronze, Brushed Bronze, Antique Brass, White and Matte Black

**Glass Thickness Range:**

1/2", 3/8", 5/16", and 1/4" (12, 10, 8, and 6 mm)

**Hole Diameter Required:**

1/2" (12 mm)



**CAT. NO. SDK112**  
(Without Plastic Sleeve)  
Back-to-Back Knob

**CAT. NO. SDKP112**  
(With Plastic Sleeve)



**CAT. NO. SDK212**  
(Without Plastic Sleeve)  
Single-Sided Knob

**CAT. NO. SDKP212**  
(With Plastic Sleeve)



Plastic Sleeve

**NOTE:** Please be sure to check each Sliding Door Kit you purchase to see what accessory items are included. If you need a Handle, Knob, or Tower Bar to complete your installation, see just some of our popular choices here. For a full selection, visit us at [crlaurence.com](http://crlaurence.com), or see our SD19 Frameless Shower Door Hardware and Supplies Catalog. Caution - Not all items allow sliding doors to bypass. Call for details.



Our Cylinder Style Knob adds a simple elegance to a frameless shower enclosure. The sleek, cylindrical shape is functional without detracting from the beauty of an all glass door. The Plastic Sleeve Model is ideal for use on sliding bypass shower doors to protect the knob surface. Knob diameter is 3/4" (19 mm), and it stands 1-1/4" (32 mm) from the glass surface. The end cap for the Single-Sided Model stands only 5/32" (4 mm) from the glass surface.

# PINNACLE SERIES

- Complement Shower Enclosures Using Pinnacle, Cologne, Prima, Estate, Trianon, Plymouth, Petite Series, or Other CRL Beveled Edge Hinges

**FINISHES:**

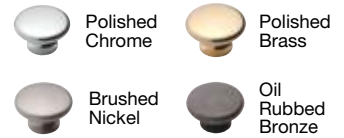

*Most models are stocked in the finishes shown here, others are available on special order.*

## GLASS SHELF



Beautiful 5/16" (8 mm) thick Glass Shelf has polished flat edge with arrises, and measures 18" x 5" (457 x 127 mm). Mounts on two Pinnacle style brackets with concealed fasteners.

CAT. NO.	FINISH
P1N812CH	Polished Chrome
P1N812BR	Polished Brass
P1N812BN	Brushed Nickel

## TOWEL BAR



Towel Bars come in 18" and 24" (457 and 610 mm) lengths with brackets styled to complement our Pinnacle Series and other beveled edge Hinges. Bar measures 5/8" (16 mm) in diameter. Concealed fasteners included.

CAT. NO.	SIZE	FINISH
P1N80018CH	18"	Polished Chrome
P1N80018BR	18"	Polished Brass
P1N80018BN	18"	Brushed Nickel
P1N80024CH	24"	Polished Chrome
P1N80024BR	24"	Polished Brass
P1N80024BN	24"	Brushed Nickel

## SOAP DISH

Oval shaped glass Soap Dish rests in a wall-mounted support that complements our Pinnacle Series and other beveled edge Hinges. Concealed fastener included. Dish measures 5-3/8" x 4-3/8" (136 x 111 mm).



CAT. NO.	FINISH
P1N850CH	Polished Chrome
P1N850BR	Polished Brass
P1N850BN	Brushed Nickel

## TOWEL RING

Towel Ring with a single bracket designed to complement our Pinnacle Series and other beveled edge Hinges. Concealed fastener included. Ring measures 6" (152 mm) in diameter.



CAT. NO.	FINISH
P1N820CH	Polished Chrome
P1N820BR	Polished Brass
P1N820BN	Brushed Nickel

## TOOTHBRUSH HOLDER

Truly elegant 4-3/4" (120 mm) tall clear glass tumbler rests in a wall-mounted support that complements our Pinnacle Series and other beveled edge Hinges. Makes a stylish Toothbrush Holder. Concealed fastener included.



CAT. NO.	FINISH
P1N861CH	Polished Chrome
P1N861BR	Polished Brass
P1N861BN	Brushed Nickel

## TOILET TISSUE HOLDER

Toilet Tissue Holder has a spring-loaded spindle resting in twin supports that complement our Pinnacle Series and other beveled edge Hinges. Concealed fasteners included.



CAT. NO.	FINISH
P1N830CH	Polished Chrome
P1N830BR	Polished Brass
P1N830BN	Brushed Nickel
P1N8300RB	Oil Rubbed Bronze



# GENEVA SERIES

- Styled to Complement Enclosures Using Geneva, Junior Geneva, Cardiff, Senior Cardiff, Concord, Victoria, Melbourne, Vienna Series, or Other Square Cornered CRL Hinges

**FINISHES:**



*Most models are stocked in the finishes shown here, others are available on special order.*

## GLASS SHELF



Beautiful 5/16" (8 mm) thick glass shelf has polished flat edge with arrises, and measures 18" x 5" (457 x 127 mm). Supported by two Geneva style wall-mounted brackets with concealed fasteners.

CAT. NO.	FINISH
<a href="#">GEN812CH</a>	Polished Chrome
<a href="#">GEN812BR</a>	Polished Brass
<a href="#">GEN812BN</a>	Brushed Nickel

## TOWEL BAR



Towel Bars come in 18" (457 mm) and 24" (610 mm) lengths with brackets styled to complement our popular Geneva Series and other square cornered Hinges. Bar measures 5/8" (16 mm) in diameter. Concealed fasteners included.

CAT. NO.	SIZE	FINISH
<a href="#">GEN80018CH</a>	18"	Polished Chrome
<a href="#">GEN80018BN</a>	18"	Brushed Nickel
<a href="#">GEN80024CH</a>	24"	Polished Chrome
<a href="#">GEN80024BR</a>	24"	Polished Brass
<a href="#">GEN80024BN</a>	24"	Brushed Nickel

## SOAP DISH

Oval shaped glass Soap Dish measures 5-3/8" x 4-3/8" (136 x 111 mm), and rests in a wall-mounted support that complements our popular Geneva Series and other square cornered Hinges. Concealed fastener included.



CAT. NO.	FINISH
<a href="#">GEN850CH</a>	Polished Chrome
<a href="#">GEN850BN</a>	Brushed Nickel

## TOWEL RING

6" (152 mm) diameter Towel Ring has a single bracket styled to complement our popular Geneva Series and other square cornered Hinges. Concealed fastener included.



CAT. NO.	FINISH
<a href="#">GEN820CH</a>	Polished Chrome
<a href="#">GEN820BN</a>	Brushed Nickel

## TOOTHBRUSH HOLDER

Perfect for use as a Toothbrush Holder, this 4-3/4" (120 mm) tall clear glass tumbler rests in a wall-mounted support that complements our popular Geneva Series and other square cornered Hinges. Concealed fastener included.



CAT. NO.	FINISH
<a href="#">GEN861CH</a>	Polished Chrome
<a href="#">GEN861BN</a>	Brushed Nickel

## TOILET TISSUE HOLDER

Complete the job with this Toilet Tissue Holder which has a spring-loaded spindle resting in twin supports that complement our popular Geneva Series and other square cornered Hinges. Concealed fasteners included.

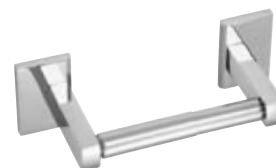

CAT. NO.	FINISH
<a href="#">GEN830CH</a>	Polished Chrome
<a href="#">GEN830BR</a>	Polished Brass
<a href="#">GEN830BN</a>	Brushed Nickel

## FRAMELESS PIVOT MIRRORS

- Beautiful 'All-Glass' Design
- Folds to Wall When Not in Use
- Completely Adjustable for Hands-Free Use
- Clear 3/16" (5 mm) Mirror has Radius Corners and Pencil-Polished Edges
- Two Popular Designer Finishes



**FINISHES:**



CRL offers a uniquely designed series of Frameless Pivot Mirrors featuring through-glass mounting hardware for an 'all-glass' appearance. These Mirrors have high quality 3/4" (19 mm) tubing and mounting components to provide strength and an attractive designer look to your bath or dressing room. The polished chrome and brushed nickel finishes match our Frameless Shower Door Hinges and Pulls.

The Frameless Pivot Mirror pivots to provide a 'surround' view, and folds to the wall when not in use. The surface of the mirror sits only 2" (51 mm) off the wall when folded flat. Two available sizes to accommodate hotel, retail or residential applications. These easy-to-install mirrors have a matching finish all-metal back that is adhered to the glass mirror for safety. Mirrors are packed to arrive safely, and come complete with installation instructions and mounting hardware. **NOTE:** Frameless Pivot Mirrors in custom sizes are available by special order. Contact us for details.

### 15" X 23" FRAMELESS PIVOT MIRRORS

- Ideal Size for Bath or Dressing Rooms
- Folds Flat When Not in Use

**CAT. NO. FPM1523CH**  
Polished Chrome

**CAT. NO. FPM1523BN**  
Brushed Nickel



Overall Mirror Dimensions:  
15" x 23" (381 x 584 mm)

### 15" X 15" FRAMELESS PIVOT MIRRORS

- Typical Applications Include Hotel Rooms, Retail Dressing Rooms, and Guest Bathrooms

**CAT. NO. FPM1515CH**  
Polished Chrome

**CAT. NO. FPM1515BN**  
Brushed Nickel



Overall Mirror Dimensions:  
15" x 15" (381 x 381 mm)

This size is the perfect complement to your master bath or dressing room. When pivot arms are fully extended the mirror is 15-1/2" (394 mm) out from the wall surface, providing ample room for adjustment to any viewing angle. You can choose from two popular finishes.

Easy-to-install, highly functional Frameless Pivot Mirrors are perfect in so many places. The 3/16" (5 mm) thick mirror has rounded pencil-polished edges, and is securely attached to the all-metal back finished to match the pivot arms and mounting hardware. Choose from two decorator finishes.

# MIRROR PIVOTS

- Simple and Easy to Install
- Hold 1/8" to 1/4" (3 to 6 mm) Mirror (Not Included)

**FINISHES:**



**CAT. NO. MP6408**  
Polished Chrome  
**VICTORIAN STYLE**



**CAT. NO. MP6208**  
Polished Chrome  
**PORCELAIN STYLE**



**CAT. NO. MP6208BN**  
Brushed Nickel  
**PORCELAIN STYLE**



**CAT. NO. MP8608**  
Polished Chrome  
**BELL STYLE**



**CAT. NO. MP64080RB**  
Oil Rubbed Bronze  
**VICTORIAN STYLE**



**CAT. NO. MP6408BN**  
Brushed Nickel  
**VICTORIAN STYLE**



**CAT. NO. MP62080RB**  
Oil Rubbed Bronze  
**PORCELAIN STYLE**



**CAT. NO. MP8608BN**  
Brushed Nickel  
**BELL STYLE**



**CAT. NO. MP86080RB**  
Oil Rubbed Bronze  
**BELL STYLE**

Our Mirror Pivots will enhance any bath or dressing room. You can install these Pivots anywhere wall space is available and, within minutes, have a useful accessory that will last for years. Mirror Pivots will accommodate 1/8" to 1/4" (3 to 6 mm) thick mirror (not included) of just about any configuration, and will hold up to 30 pounds (13.6 kg). Full length vanity mirrors can be mounted and tilted to view any height. Pivots are made of heavy plated cast brass, and beautifully finished. Mounting hardware is included. Sold only by the pair. **NOTE:** Not designed for use with beveled mirror. Mirror Pivots work best with flat polished or pencil polished edges. CRL recommends using Cat. No. 2MT24 Shatterproof Safety Tape for mirrors being installed into Mirror Pivots.



# PIVOT-N-VIEW DOUBLE-HINGED MIRRORS

- Swings Out and Stays in Place for Hands-Free Viewing
- Provides Full Back and Side Views
- Comes Complete With Glass Mirror
- Two Finishes to Choose From

**FINISHES:**



The Pivot-N-View Mirror is perfect for residential and hotel bathrooms or retail store dressing rooms. It is almost infinitely adjustable, and provides the user with full back and side views. Pivot-N-View Mirrors are designed for installation on a sidewall within 18" (457 mm) or less from the existing mirror. The mirror may also be installed on an opposite wall. Pivot-N-View Mirrors have a 180° arc from the wall plus 360° capability within their own frames. All frames can be mounted on the right or left hand wall by simply reversing the hinges. The arms extend a total length of 10" (254 mm) from the wall. It ships complete with mounting instructions and hardware, making this product easy to install.



14" x 22"  
(355 x 558 mm)



11" x 11"  
(279 x 279 mm)

CAT. NO.	SIZE (W X H)	FINISH
PV11CH	11" x 11" (279 x 279 mm)	Polished Chrome
PV11BN	11" x 11" (279 x 279 mm)	Brushed Nickel
PV14CH	14" x 22" (355 x 558 mm)	Polished Chrome
PV14BN	14" x 22" (355 x 558 mm)	Brushed Nickel

# CRL CLEAR VIEW™ MIRROR DEFOGGERS



- Enjoy the Clarity of a Mirror That Automatically Defogs
- Fast, Simple, and Cost Efficient Installation
- U.L. Approved

CRL Clear View™ Mirror Defoggers are specially designed thin heating elements that are adhered to the back of mirrors, gently raising their temperature just enough to keep the mirror dry and clear in high humidity conditions. Wiping moisture off the mirror with a towel is unnecessary, making shaving and applying makeup easier.

Low voltage CRL Clear View™ Mirror Defoggers are available in three shapes and in two sizes each that can be incorporated into virtually any mirror design. They are easy to install by wiring to any power source, but the most common method is to wire to the bath's 120V AC vanity light switch. Each maintenance-free Defogger carries a five year unconditional guarantee. **NOTE:** Maximum temperature is 64°F (18°C) above room temperature.

Custom sizes and 220 Volt models are available on special request. For additional information, contact CRL Technical Sales at (800) 421-6144 in the U.S., (877) 421-6144 in Canada, or (323) 588-1281 International, and ask for Ext. 7700. You can also send an e-mail to [glazing@crlaurence.com](mailto:glazing@crlaurence.com).



## CRL RECTANGULAR CLEAR VIEW™ MIRROR DEFOGGERS

The Rectangular Clear View™ Mirror Defogger fits a wide variety of applications. They can be mounted in a vertical or horizontal position to suit the mirror's dimensions and your needs.

CAT. NO.	SIZE	POWER RATING (WATTS@120V AC)	ENERGY CONSUMPTION (KWH@120V AC)
R1826	18" x 26" (457 x 660 mm)	57	0.057
R2432	24" x 32" (610 x 813 mm)	96	0.096

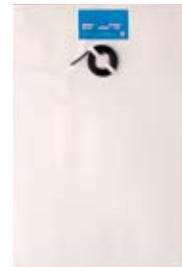

## CRL OVAL CLEAR VIEW™ MIRROR DEFOGGERS

The cameo shape of the Oval Clear View™ Mirror Defogger provides the effect of a "mirror-in-a-mirror" as the clear vision of the heated area is bordered by the moist area of the unheated portion of the mirror. They can be mounted vertically or horizontally for the appropriate appearance.

CAT. NO.	SIZE	POWER RATING (WATTS@120V AC)	ENERGY CONSUMPTION (KWH@120V AC)
O1826	18" x 26" (457 x 660 mm)	45	0.045
O2432	24" x 32" (610 x 813 mm)	76	0.076



## CRL ROUND CLEAR VIEW™ MIRROR DEFOGGERS

Our 15" (381 mm) and 20" (508 mm) Round Clear View™ Mirror Defoggers can be positioned according to your height requirements. Consider using two Defoggers when installing over counters with two basins.

CAT. NO.	RADIUS	POWER RATING (WATTS@120V AC)	ENERGY CONSUMPTION (KWH@120V AC)
R15	15" (381 mm)	20	0.020
R20	20" (508 mm)	41	0.041

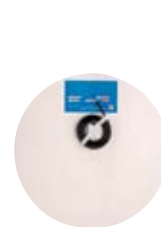

# ACCESSORIES FOR THE DESIGNER BATHROOM

## DELUXE SHOWER SQUEEGEES

- Suction Hook Holder Requires No Drilling
- 10" (254 mm) Gray Rubber Blade
- Two Models to Choose From



**CAT. NO. 17600**  
Standard Model



**CAT. NO. 17900**  
Extendable Model

CRL's Deluxe Shower Squeegee has a sturdy chrome plated, zinc diecast handle that is rust and tarnish free. The polished stainless steel blade holder secures a 10" (254 mm) wide, gray colored blade that effectively removes water spots and soap film from all types of bathroom surfaces. The Squeegee hangs on an attractively designed suction hook that installs easily onto the shower wall. The blade is reversible to extend its service life. The Extendable Model extends from 12" to 18" (305 to 457 mm) for those hard to reach areas. A strong suction cup holder is included for convenient storage. The Extendable Model comes in chrome finish. The stainless steel blade holder secures a 10" (254 mm) wide gray blade. Replacement Blade for both squeegees is RB17600.

## CRYSTAL CLEAR SQUEEGEE

- Crystal Clear Appearance Blends Beautifully With Glass
- Helps Prevent Accumulation of Mildew, and Eliminates Water Spots When Used After Each Shower
- Stainless Steel Blade Holder With 10" (254 mm) Gray Rubber Blade
- Includes Strong Suction Cup Holder for Handy Storage



**CAT. NO. CCS1**

The Crystal Clear Squeegee can be used after each shower to quickly wipe the glass to a spot-free finish, assisting in preventing mildew. The stylish, ergonomically designed handle is made of durable acrylic, and the stainless steel blade holder has a 10" (254 mm) gray color rubber blade. The Crystal Clear Squeegee remains rust and tarnish free, and comes with a strong suction cup holder for convenient storage.

## SUPERIOR SQUEEGEES

- Dual 10" Wide Blades Wipe Water From Enclosure Door and Walls

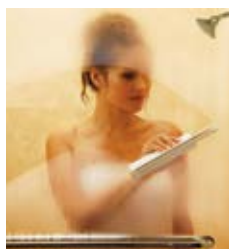

**CAT. NO. SQBC1**  
Black/Chrome



**CAT. NO. SQWC1**  
White/Chrome

Superior Squeegees have decorative chrome plated end caps on white or black wiping blades and handles. This upscale combination of function and design makes it easy to wipe water from shower doors, glass, tile, and marble surfaces. Dual 10" (254 mm) blades are held in an 8" (203 mm) handle.

## CRL VACUUM SQUEEGEE

- Dripless, Streak Free Surface Clean-Up
- Rechargeable Power
- Save on Wipes and Towels



The CRL Vacuum Squeegee can be used on windows, shower enclosures, shower tile, counter tops, or any other smooth and flat vertical or horizontal surface. The Squeegee's rechargeable battery provides 20 minutes of service per charge, and its clear reservoir lets you keep track of the amount of liquid vacuumed.

CAT. NO.	DESCRIPTION
VS20	110V AC Vacuum Squeegee
EUVS20	240V AC Vacuum Squeegee

*Minimum order: 1 each.*

# PRODUCTS TO MAINTAIN ELEGANT DESIGNER BATHROOMS

## GLASS CLEANER

1973 Glass Cleaner, a long time favorite of CRL customers, is a low-ammoniated glass cleaner with effective agents and a pleasant aroma. Excellent for all glass and mirror surfaces. 19 ounce (539 g) aerosol can. Minimum order one case. 12 cans per case.

Smaller 4 oz. (113 g) M1973 Mini Cans makes excellent promotional giveaways for repeat business. 12 cans per case.



CAT. NO. M1973

CAT. NO. 1973

## BIO-CLEAN WATER STAIN REMOVER

- Works Great on Shower Doors, Tile, Aluminum, and Much More

Professional strength cleaner successfully used in hospitals, nursing homes, hotels, and other facilities with difficult to clean surfaces. Apply to surface with a dry cloth, sponge, brush, or oscillating buffer. Press firmly to loosen stain with a rubbing action, then just rinse with water until residue free. 16 ounce (473 ml) bottle. Minimum order is one bottle. You may also order our Cat. No. WSR1P, which is five sample pouches. Handy to have your customers to try.



CAT. NO. WSR1

## SPARKLE STAIN REMOVER

"Sparkle" Stain Remover does those glass cleaning jobs too tough for spray-on cleaners. It removes light water spots and stains in glass caused by weather, sea air or pollution; also removes soap scum from shower doors and ceramic tile. Wipe on with a damp cloth or paper towel, rub stained areas, then wipe off. 8 ounce (236 ml) bottle. Minimum order is one bottle.



CAT. NO. SP101

## A-MAZ WATER STAIN REMOVER

- Removes the Toughest Stains
- Contains No Acids, Bleach, or Chlorides
- Includes Nylon Scrub Pad

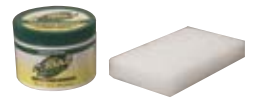

CAT. NO. 3379520

A-Maz Water Stain Remover removes the toughest stains on glass, chrome, porcelain, fiberglass, metal, tile - water stains, mineral deposits, and sealant stains. It can also be used on all types of bathroom surfaces to remove lime scale, oxidation and soap scum. A nylon pad is provided with product. Pad measures approximately 6" x 3-1/2" x 1" (152 x 89 x 25 mm). Stain Remover has a net weight of 14 oz. (396 grams).

## TPC SURFACE PROTECTOR

TPC Surface Protector seals the pores of glass, porcelain, ceramic, and marble to make the surface water, soil, and stain resistant. A transparent polymer coating (TPC) guards against the adhesion and build-up of dirt, grime, mold, mildew, rust, and mineral deposits. Simply wipe on and polish off. 16 ounce (473 ml) pump spray bottle. One ounce will protect approximately 15 square feet of glass. Minimum order is one bottle.



CAT. NO. TPC16

## AUTOSOL® SHINE METAL CLEANER

- Polishes All Metal Surfaces
- Ideal for Shower Door Hardware

Autosol® Shine cleans, restores, and polishes all metal surfaces. Protects against corrosion and tarnishing. Ideal for cleaning and maintaining CRL Shower Door Hardware. 2.5 ounce (75 ml) tube. Minimum order is one each.



CAT. NO. 1188AS

## LINT FREE GLASS WIPES

Highly absorbent Lint Free Paper Wipes clean glass and mirror surfaces without leaving any residue. Each BX15 pop-up dispenser box holds 150 wipes. 1550 Case contains six BX15 boxes. Wipes measure a big 9-3/4" x 16-1/2" (248 x 419 mm).



CAT. NO. 1550  
Contains six BX15

CAT. NO. BX15  
Box holds 150 Wipes

## MICRO FIBER WIPES

- Streak Free Cleaning on Shower Doors and Mirrors
- Washable Up to 500 Times

CRL Micro Fiber Wipes have thousands of microscopic fibers that trap dirt and grime to increase cleaning effectiveness and reduce cleaning and drying times. Large 16" x 16" (406 x 406 mm) size takes on big cleaning, waxing, polishing, and dusting jobs. Sold by the pack. Two wipes per pack. Minimum order is one pack.



CAT. NO. MFW2

# SHOWERS ONLINE®

## WEB-BASED DESIGN, GLASS SIZING, QUOTE, AND ORDERING PROGRAM

- Program Generates Completed Quotes and Allows Easy Conversion to Orders
- Generates “Go” Glass Sizes From Your Field Measurements
- Sizes for Shower Enclosures Can Be Completed in Just a Few Minutes
- Upon Completion of Data Entry, Simply Push the “Print” Icon to Generate Complete Glass Sizes and Their Templates
- Glass Sizes and Pricing for Serenity, Cottage, Cambridge, Essence, Cabo, and Hydroslide Series Sliding Systems Can Be Done
- Quote Requests for Custom Items Can Be Generated
- You Have the Ability to Change the Default Deductions for Glass Sizing
- Continued Upgrades to Program Occur at No Extra Expense to You

Now, you no longer have to figure glass sizes by hand. Showers Online is a web-based design and glass sizing program that allows you to enter a list of products being used for a particular job, and the field measurements for the installation. Showers Online then calculates final glass sizes and displays detailed information, including hinge and handle locations, miters, and much more. The program is tailored to work with most any shower enclosure configuration. Users can select default settings, hardware types, and clearances.

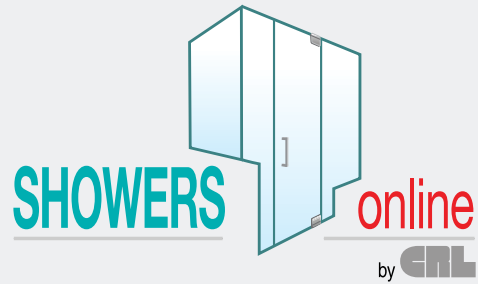
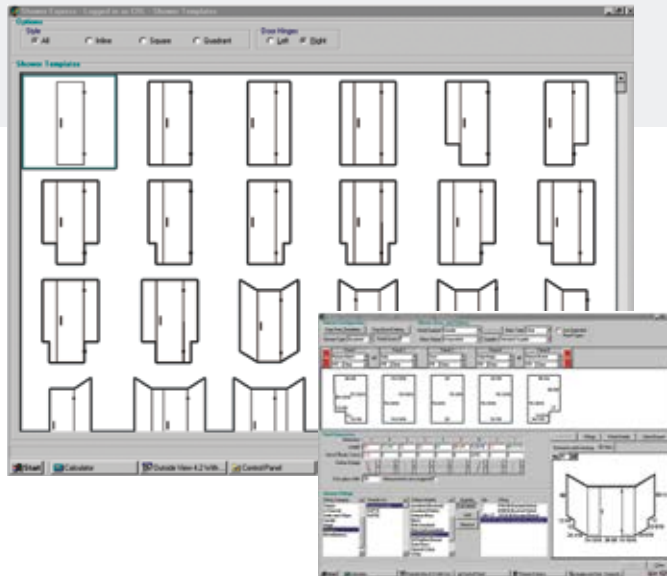

- Branding Feature to Add Your Company Logo
- DXF Export Feature for CNC Fabrication Needs
- Web-Based So You Have 24 Hour Access
- 3D Color Images

A quote sheet can be assembled for a professional and personalized quote you can send to a prospective customer. Shower hardware specific to each enclosure can be ordered from Showers Online®.

Showers Online is available only to CRL Authorized professional installers who first attend an introductory Webinar. For additional information, contact CRL Technical Sales at (800) 421-6144 in the U.S., (877) 421-6144 from Canada, or (323) 588-1281 International and ask for Ext. 7740. You can also go to our web site at [crlaurence.com/online-apps](http://crlaurence.com/online-apps).



### BENEFITS OF USING CRL'S SHOWERS ONLINE®

- Online Access Means Availability to the Program Anytime, Anywhere... From the Office, Shop, Field, or Anywhere Access is Required
- Accurately Calculates Correct Glass Sizes, and All Hardware Locations, Cut-Outs and Gaps
- Sophisticated CAD Processing Takes Place on Our Web Servers
- Issues Warnings About Possible Problems With the Shower Design
- PC, MAC, Tablet, and iPad Compatible
- Generates Quotes Using All Job Costs Including Hardware, Glass, Labor, Travel and So On, Then You Can Mark Up Selling Price

## ACKNOWLEDGEMENTS

C.R. Laurence Company, in partnership with many of the finest glass and mirror businesses worldwide, is proud to make this catalog available. We thank these companies for allowing us to showcase their beautiful shower installations in our book.

Al's Quality Shower Door .....	09, 12	Elite Glass & Mirror, Inc. ....	25
American Frameless .....	IFC (lower right, center), 04, 05 (lower left), 17, 26	Larry Gautreau Co. ....	01 (top right)
Bay Glass Works, Inc. ....	Cover, 2	Liberty Glass & Mirror .....	25
Crystal Glass & Mirror Corp. ....	10, 14, 25	Palgrave Glass and Mirror .....	08, 01 (lower right)
Custom Closet and Glass .....	06	SouthShore Shower Door .....	20, 25

## CRL MASTER & SPECIALTY CATALOGS

Can be ordered, viewed or downloaded at [crlaurence.com](http://crlaurence.com)

### CRL MASTER CATALOGS

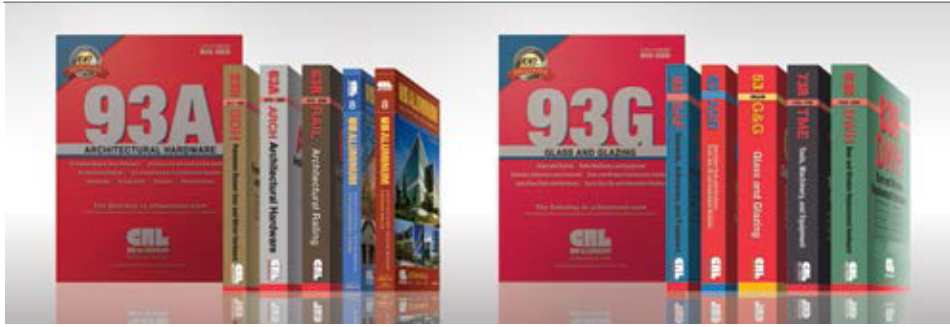

- 93A** ARCHITECTURAL HARDWARE
- 93G** GLASS AND GLAZING
- 03** SEALANTS, ADHESIVES, AND FASTENERS
- 23R** FRAMELESS SHOWER DOOR HARDWARE
- 43** AUTO GLASS TOOLS AND WINDOWS
- 53R** GLASS AND GLAZING HARDWARE
- 63A** ARCHITECTURAL HARDWARE
- 63R** ARCHITECTURAL RAILING
- 73R** TOOLS, MACHINERY, AND EQUIPMENT
- 83R** DOOR AND WINDOW REPLACEMENT HARDWARE
- USAL14** ARCHITECTURAL DESIGN MANUAL ENTRANCES
- USAL15** ARCHITECTURAL DESIGN MANUAL CURTAIN WALLS

### CRL SHOWER CATALOGS & BROCHURES



**CRL23R**  
Shower Door and  
Mirror Hardware  
Master Catalog



**SD19**  
Frameless  
Shower Door  
Hardware



**ST14**  
Frameless Shower  
Door Professional  
Installation Tools



**10 2819 CRL**  
Buyline 3068  
Frameless Shower Door  
Hardware and Supplies



**FF4SD**  
Frameless Shower  
Door Folding Flyer



**SDT21**  
Frameless Shower  
Door Hardware  
Template Guide

### CRL SPECIALTY CATALOGS



**AH18**  
Architectural  
Hardware



**HR18**  
Architectural  
Railing Systems



**DC14**  
Door Controls  
Hardware and  
Accessories



**TH18**  
Transaction and  
Security  
Hardware



**HS12**  
Hospitality and  
Service  
Hardware



**SC18**  
Standoff and  
Clamp Hardware



**GB10**  
Glass Bonding  
System

VISIT THE WORLD OF [crlaurence.com](http://crlaurence.com)



- Access to All CRL Products Through CRL's Comprehensive Product Index
- View All Current CRL Catalogs Online
- New CRL Products and Services
- Technical Articles and Product Support
- Ordering and Shipping Information
- Help in Using the Site
- A Calendar of Industry Trade Shows
- CRL Locations with Addresses, Directions, Phone and Fax Numbers
- Direct E-Mail Connections to CRL Departments
- Account Policies and Credit Terms



**C.R. LAURENCE CO., INC.**  
2503 E. Vernon Ave.  
Los Angeles, CA 90058-1826  
Phone: (800) 421-6144 Ext. 17740  
Fax: (800) 458-7496  
E-mail: [showers@crlaurence.com](mailto:showers@crlaurence.com)

[crlaurence.com](http://crlaurence.com)

[usalum.com](http://usalum.com)

[crl-arch.com](http://crl-arch.com)